



---

**Pre-installation Data Sheet**

Bathtubs and Whirltubs

## Index

---

|  |   |
|--|---|
| Notes.....                                   | 2 |
| Pre-installation .....                       | 3 |
| Maintenance openings .....                   | 5 |
| Data sheets for bathtubs and whirltubs ..... | 9 |

## Notes

---

### PLANNING

Before starting the installation, plan the layout in detail, taking the site conditions into consideration.

### TARGET READERSHIP AND QUALIFICATIONS

All work associated with the installation and water connection may only be undertaken by a plumber and all work associated with the electrical installation may only be undertaken by a licensed electrician.

### SAFETY INSTRUCTIONS

#### **Incorrect handling/transport may result in product damage.**

The metal frame and whirl system are not resilient.

- > Never hold by the metal frame or whirl system.

Improper transport can cause damage to the product and/or property damage, e.g. leaks.

- > Wear appropriate protective clothing.
- > Avoid knocks.

#### **Risk of product and/or property damage!**

The breach of local and country-specific regulations and standards can cause damage to the product and/or property damage.

- > Observe the local installation regulations and any country-specific standards at all times.

Duravit AG assumes no liability for the consequences of improper handling or improper transport.

## Pre-installation

### INSTALLATION LOCATION / INSTALLATION ROOM

> Make sure that the installation location fulfils the following criteria

|                                |  |
|--------------------------------|--|
| <b>Doors / external access</b> | <ul style="list-style-type: none"> <li>Ensure that doors or other access openings are large enough to accommodate transport dimensions, keeping in mind the weight and need for sufficient manoeuvring room.</li> </ul>  |
| <b>Required area</b>           | <ul style="list-style-type: none"> <li>Allow for enough space around the tub for the installation.</li> </ul>  |
| <b>Floor</b>                   | <ul style="list-style-type: none"> <li>Completely level.</li> <li>At a right angle to the wall.</li> <li>Note the overall strength of the floor structure including the floor finish.</li> <li>There must not be any underfloor heating under the tub.</li> <li>Install tubs <b>after</b> the tiles. (Top edge of finished floor).</li> <li>Depending on the combination of tub and whirl system it is possible that system components may protrude beyond the edge of the tub. We therefore recommend installation in a support frame.</li> <li><b>Tolerances for acrylic:</b> As a result of the manufacturing process, deviations from the nominal dimensions may occur within the limits specified in the DIN 198 standard. Please take this into account in your planning.</li> </ul> |
| <b>Wall</b>                    | <ul style="list-style-type: none"> <li>Tiled.</li> <li>At a right angle to the tub.</li> <li>Completely straight.</li> <li>Note the overall strength of the wall structure including the wall finish.</li> </ul>   |

### WATER INSTALLATION

#### NOTE

Bathtubs without overflow will overflow into the room.

> If a bathtub is installed without an overflow, a floor drain must be installed to protect the building against overflow water in accordance with DIN 1986-100.

#### NOTE

A pipe interrupter is absolutely essential for tubs with a base inlet (DIN EN 1717).

> Comply with assembly scheme.

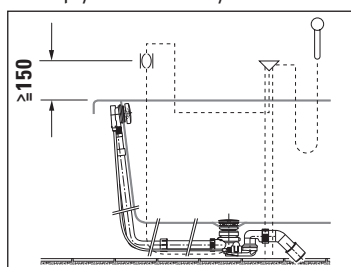

### Water connection

- Connections for the water supply and drains must be in compliance with the currently valid standards and public regulations.
- Position the water drain (DN 50) flush to the mounting surface or out of the wall directly above the mounting surface; see drawing for recommended area.

### MAINTENANCE OPENINGS AND AIR SUPPLY

#### NOTE

It is recommended to install the tub with a removable bathtub panel due to the improved maintenance options.

#### Tiling the tub

The following maintenance openings must be provided:

- Cable-driven waste and overflow 200 x 200 mm
- Units 500 x 500 mm  
(Please see the section on "Maintenance openings")
- Provide an opening in the panel for the air supply with an effective area of approx. 15cm<sup>2</sup> (e.g. 3 x 5 cm or 2 x 7.5 cm).

#### Tub with a panel

- The panel must be removed for maintenance, and with a seamless panel, the tub must be removed from the wall. Your plans should therefore include a clearance in front of the tub.
- The air supply for the whirl system (ventilation grille/ventilation slot) must not be covered.

### ELECTRICAL INSTALLATION



**DANGER**

**Risk of fatal electric shock**

- Disconnect the power supply while working on the electrical components.
- The device must be earthed. Earthed appliances must be permanently connected to fixed wiring.
- Connect the device only to the designated electrical cable.
- NEVER touch the power supply line with wet hands.

### Pre-installation

- Lay a permanent power supply line which must be on a separate circuit.
  - The device itself does not have electrical leakage protection function. The device must be supplied through a residual current device (RCD) with a rated residual operating current not exceeding 30 mA.
  - Means for disconnection must be incorporated in the fixed wiring in accordance with the wiring rules and have a contact separation in all poles that provides full disconnection under overvoltage category III conditions outside the prescribed protection zones (0 – 2).
  - Leave 3000 mm of the supply line exposed.
- Lay an equipotential bonding cable:
  - Leave 3000 mm of cable exposed.
- Select a supply line cross-section based on the connected load on the identification plate (2.5 mm – 4 mm).
- Confirm that the grounding wire is 10 mm (3/8") longer than the L and N wire.

> Install a circuit breaker.

# 76XXXX XX X XX XXX6: 220 – 240 V AC, 60 Hz

**Fuse**  $I_N = 16 \text{ A}$

**RCD**  $I_{\Delta N} \leq 30 \text{ mA}$

## PROTECTION ZONES

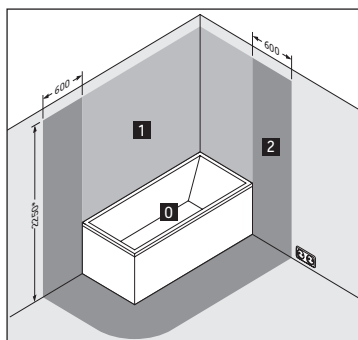

\* Or the height of the highest fixed-location shower head/water outlet, whichever is higher.

## WHITE LED LIGHT UNDER THE EDGE OF THE TUB FOR BATHTUBS

### Electrical data

#### Power supply

|   |                                   |
|---|-----------------------------------|
| White LED light under the edge of the tub<br>#791847 00 0 00 0000<br>#791848 00 0 00 0000<br>#791849 00 0 00 0000 | 220 – 240 V AC, 50/60 Hz,<br>50 W |
|---|-----------------------------------|

**Fuse**  $I_N = 16 \text{ A}$

**RCD**  $I_{\Delta N} \leq 30 \text{ mA}$

## WHIRLTUBS

### Electrical data

| Whirl system                                      | Rated power with standard equipment | Max. rated power, fully-equipped |
|---|-------------------------------------|----------------------------------|
| Air System<br>(# 760XXX XX X AS 00XX)             | 0.76 kW                             | 0.85 kW                          |
| Air System (DuraSolid)<br>(# 760XXX XX X AS 00XX) | 0.58 kW                             | 0.58 kW                          |
| Jet Project<br>(# 760XXX XX X JP 10XX)            | 0.66 kW                             | 0.66 kW                          |
| Jet System<br>(# 760XXX XX X JS 10XX)             | 0.59 kW                             | 0.67 kW                          |
| Combi-System P<br>(# 760XXX XX X CP 10XX)         | 1.89 kW                             | 1.98 kW                          |
| Combi-System E<br>(# 760XXX XX X CE 10XX)         | 1.91 kW                             | 2.96 kW                          |
| Combi-System L<br>(# 760XXX XX X CL 10XX)         | 1.59 kW                             | 2.64 kW                          |
| Jet System E<br>(# 760XXX XX X JE 10XX)           | 1.14 kW                             | 2.20 kW                          |

#### Power supply

# 76XXXX XX X XX XXX0: 220 – 240 V AC, 50 Hz

## Maintenance openings

### Maintenance

Install the whirltub in such a way that all of the important equipment (pump, blower and control system) remains accessible. It is recommended to install the tub with a removable furniture panel for easy maintenance.

### Location of the whirl system components

The illustrations show the standard configuration for the components of the whirl system\* with the location of the operating unit. The back massage is located at the head end (depending on the whirl system).

Custom-made designs available on request. In such cases we will require a drawing showing the desired layout. Duravit will confirm whether the desired layout can be implemented.

### Blue Moon

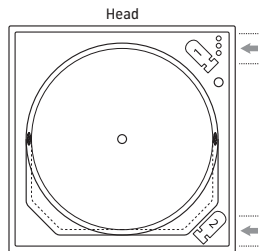

# 760143

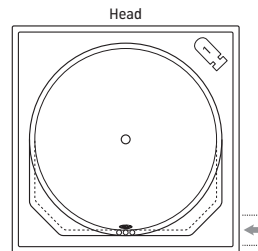

# 760402

### Cape Cod

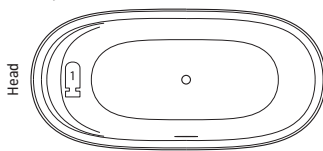

# 760330

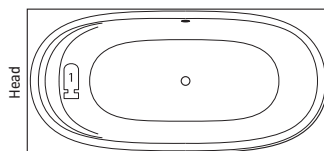

# 760362

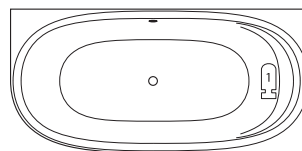

# 760363

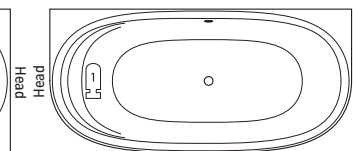

# 760364

### Darling New

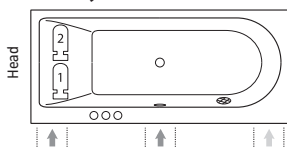

# 760242

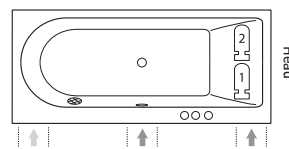

# 760243

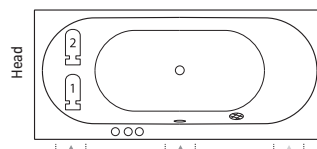

# 760244, # 760245

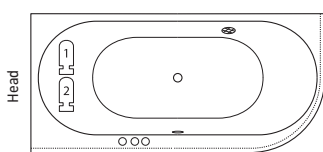

# 760246

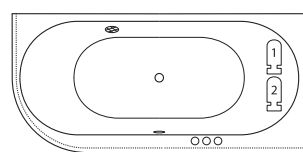

# 760247

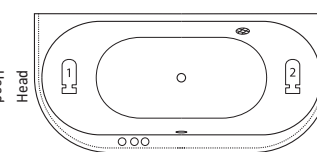

# 760248

### D-Code

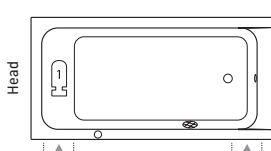

# 760095, # 760096,  
# 760098, # 760100

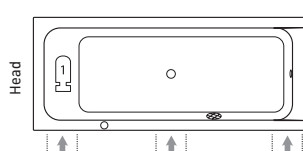

# 760097, # 760099

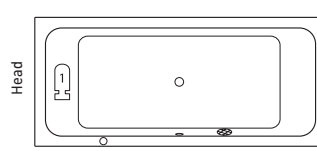

# 760101

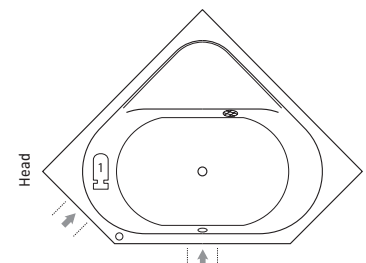

# 760137

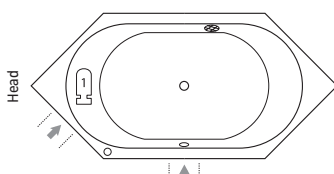

# 760138

\* Please note that depending on the combination of tub and whirl system it is possible that system components may protrude beyond the edge of the tub. We therefore recommend installation in a support frame

**D-Neo**

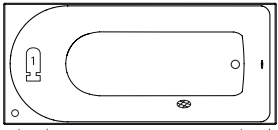

# 760471, # 760472, # 760475,  
# 760478, # 760479

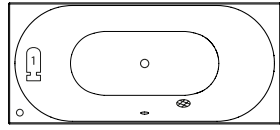

# 760476

**DuraSquare**

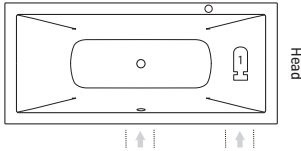

# 760426

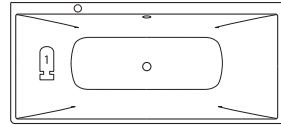

# 760427

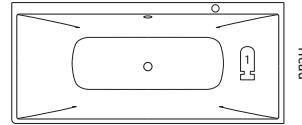

# 760428, # 760429

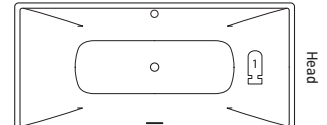

# 760430

**DuraStyle**

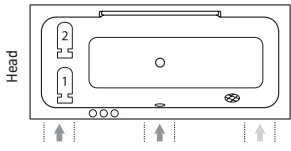

# 760292, # 760294, # 760296

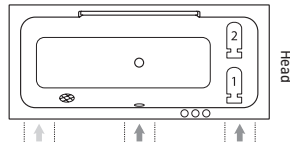

# 760293, # 760295, # 760297

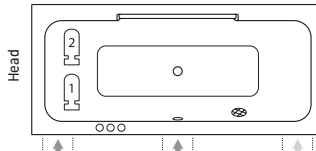

# 760298

**Happy D.2**

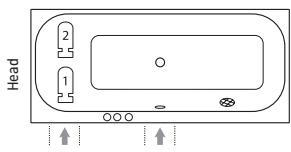

# 760308, # 760310, # 760312

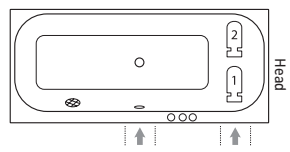

# 760309, # 760311, # 760313

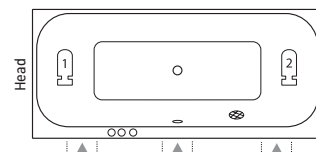

# 760314, # 760315

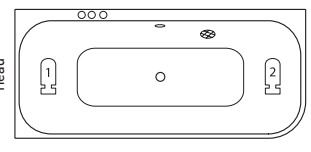

# 760316

# 760317

# 760318

**Happy D.2 Plus**

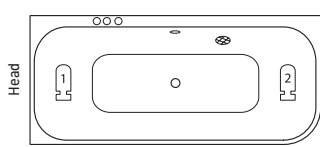

# 760449

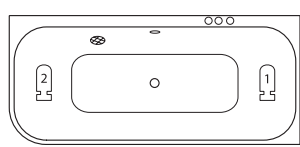

# 760450

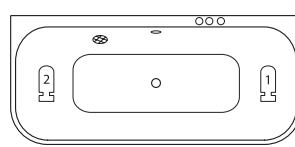

# 760451

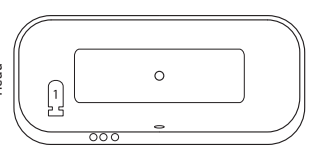

# 760453

**Luv**

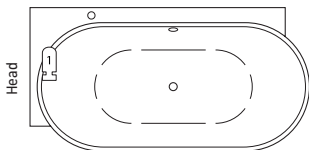

# 760431

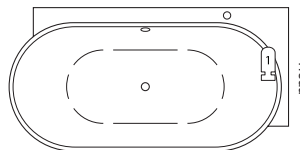

# 760432

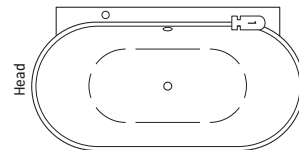

# 760433

### Paiova

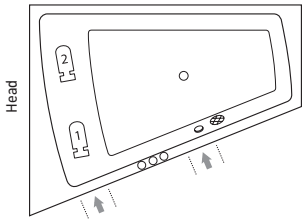

# 760212, # 760214, # 760216

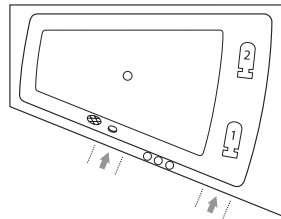

# 760213, # 760215, # 760217

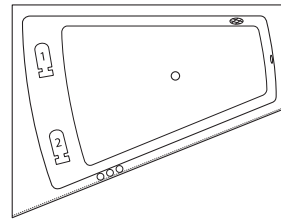

# 760264, # 760266, # 760268

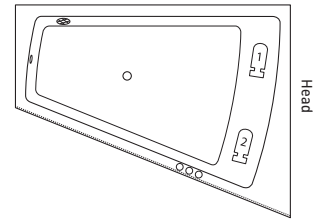

# 760265, # 760267, # 760269

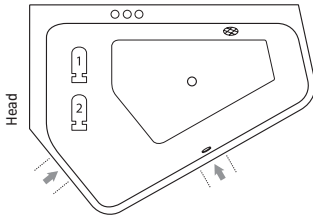

# 760390, # 760392

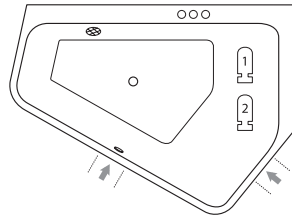

# 760391, # 760393

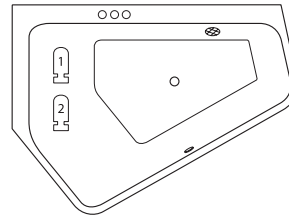

# 760394, # 760396

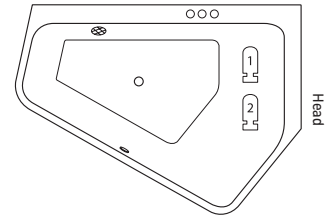

# 760395, # 760397

### Starck

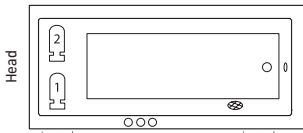

# 760050, # 760331, # 760332,  
# 760333, # 760334, # 760335,  
# 760336, # 760337

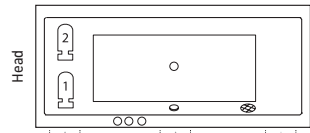

# 760052, # 760338, # 760339,  
# 760340, # 760341

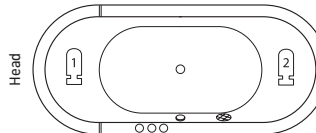

# 760009

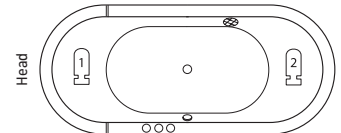

# 760010

### Vero Air

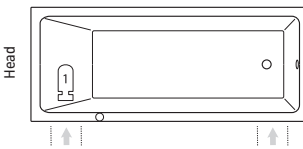

# 760411, # 760412

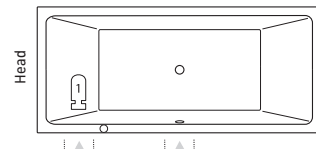

# 760413, # 760414

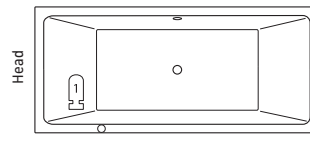

# 760418

### Vero

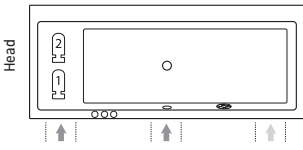

# 760133

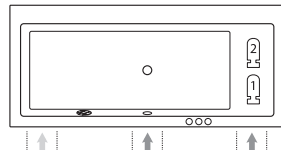

# 760134

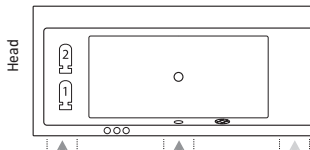

# 760135, # 760136

### Legend



Unit 1



Unit 2\*



Control panel\*\*



Suction screen



Pull button



Tap module



Recommended equipment covers



Recommended equipment covers\*\*\*

\* Only Combi-Systems / \*\* The number of operating elements is based on the whirl system and the additional modules selected / \*\*\* Only necessary for Combi-System E/L in combination with sound and/or coloured LED light





## Data sheets for bathtubs and whirltubs

# Pre-installation Luv # 7X0431

1850 x 950 x 610

Design by Cecilie Manz

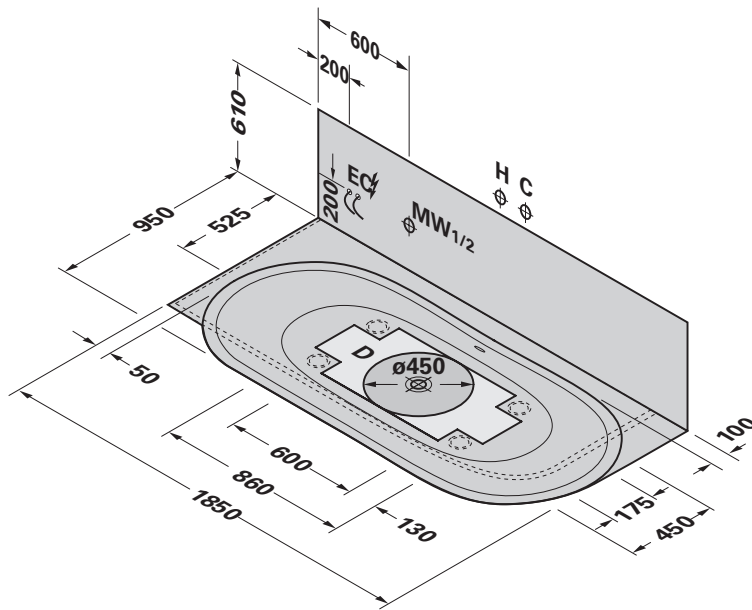

- H** Hot water connection
- C** Cold water connection
- D** Drain connection
- MW1** Mixed water connection for waste and overflow with water inlet
- MW2** Mixed water connection for waste and overflow with base inlet
- EC** Electricity connection

## Technical specifications

| Net weight<br>kg | Floor load<br>kg/m <sup>2</sup> | Shipping weight<br>kg | Shipping dimensions<br>l x w x h (cm) | Water inlet OD,<br>Base inlet OD | Whirlsystem | Model-No.           |
|------------------|---------------------------------|-----------------------|---------------------------------------|----------------------------------|-------------|---------------------|
| 105,0            | 237                             | 169,0                 | 200 x 100 x 70                        | 1/2", 3/4"                       |             | 700431 00 0 00 0000 |
| 115,0            | 243                             | 179,0                 | 200 x 100 x 70                        | 1/2", 3/4"                       | Air-System  | 760431 00 0 AS 0000 |

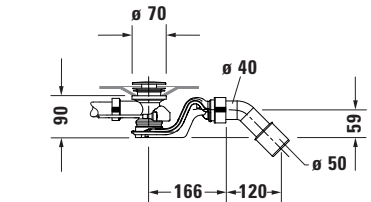

Siphon for bathtub # 700431

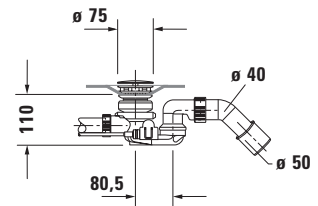

Siphon with base inlet for bathtub # 700431

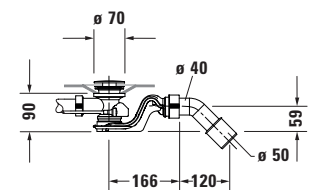

Siphon for whirltub # 760431

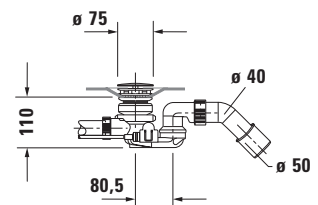

Siphon with base inlet for whirltub # 760431

# Pre-installation Luv # 7X0432

1850 x 950 x 610

Design by Cecilie Manz

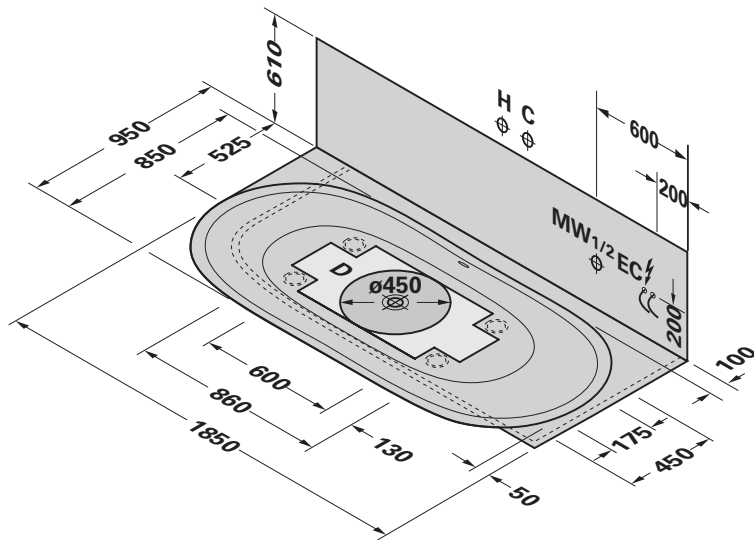

- H** Hot water connection
- C** Cold water connection
- D** Drain connection
- MW1** Mixed water connection for waste and overflow with water inlet
- MW2** Mixed water connection for waste and overflow with base inlet
- EC** Electricity connection

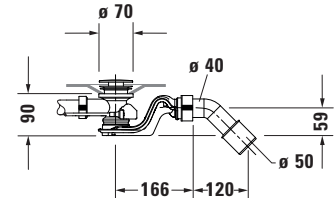

Siphon for bathtub # 700432

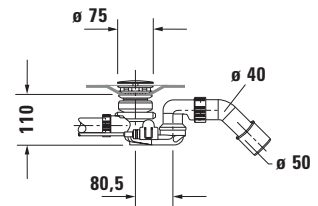

Siphon with base inlet for bathtub # 700432

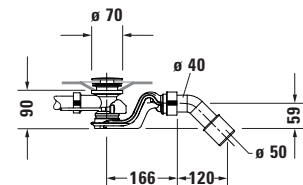

Siphon for whirltub # 760432

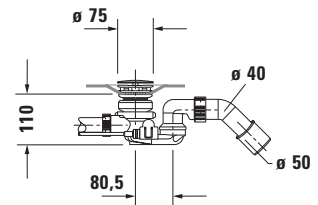

Siphon with base inlet for whirltub # 760432

## Technical specifications

| Net weight<br>kg | Floor load<br>kg/m <sup>2</sup> | Shipping weight<br>kg | Shipping dimensions<br>l x w x h (cm) | Water inlet OD,<br>Base inlet OD | Whirlsystem | Model-No.           |
|------------------|---------------------------------|-----------------------|---------------------------------------|----------------------------------|-------------|---------------------|
| 105,0            | 237                             | 169,0                 | 200 x 100 x 70                        | 1/2", 3/4"                       |             | 700432 00 0 00 0000 |
| 115,0            | 243                             | 179,0                 | 200 x 100 x 70                        | 1/2", 3/4"                       | Air-System  | 760432 00 0 AS 0000 |

# Pre-installation Luv # 7X0433

1800 x 950 x 610

Design by Cecilie Manz

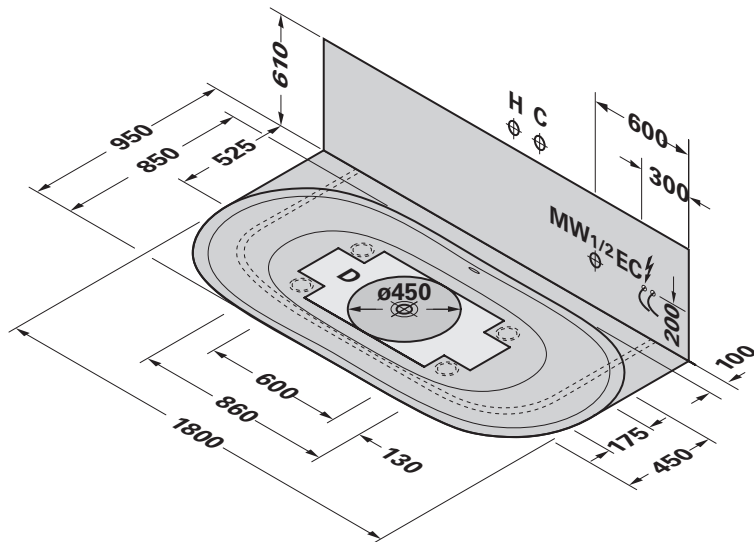

- H** Hot water connection
- C** Cold water connection
- D** Drain connection
- MW1** Mixed water connection for waste and overflow with water inlet
- MW2** Mixed water connection for waste and overflow with base inlet
- EC** Electricity connection

### Technical specifications

| Net weight<br>kg | Floor load<br>kg/m <sup>2</sup> | Shipping weight<br>kg | Shipping dimensions<br>l x w x h (cm) | Water inlet OD,<br>Base inlet OD | Whirlsystem | Model-No.           |
|------------------|---------------------------------|-----------------------|---------------------------------------|----------------------------------|-------------|---------------------|
| 110,0            | 247                             | 174,0                 | 200 x 100 x 70                        | 1/2", 3/4"                       |             | 700433 00 0 00 0000 |
| 120,0            | 253                             | 184,0                 | 200 x 100 x 70                        | 1/2", 3/4"                       | Air-System  | 760433 00 0 AS 0000 |

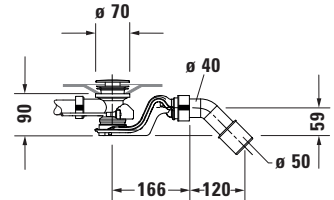

Siphon for bathtub # 700433

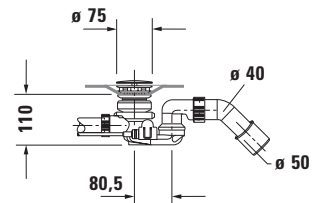

Siphon with base inlet for bathtub # 700433

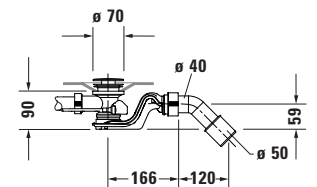

Siphon for whirltub # 760433

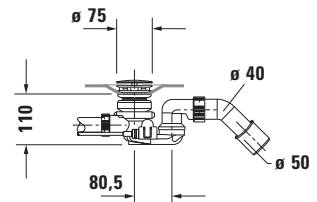

Siphon with base inlet for whirltub # 760433

# Pre-installation Luv # 700434

↳ 1600 x 750 x 615 ‹

Design by Cecilie Manz

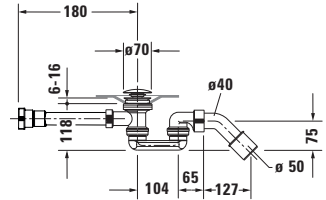
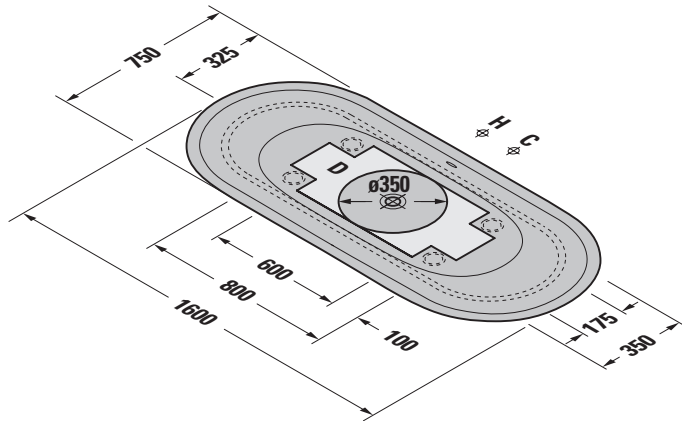

Siphon for bathtub # 700434

- H Hot water connection
- C Cold water connection
- D Drain connection

## Technical specifications

| Net weight<br>kg | Floor load<br>kg/m <sup>2</sup> | Shipping weight<br>kg | Shipping dimensions<br>l x w x h (cm) | Water inlet OD,<br>Base inlet OD | Whirlsystem | Model-No.           |
|------------------|---------------------------------|-----------------------|---------------------------------------|----------------------------------|-------------|---------------------|
| 115,0            | 284                             | 155,0                 | 180 x 95 x 85                         | -                                |             | 700461 00 0 00 0000 |

# Pre-installation Luv # 700434

1800 x 850 x 615

Design by Cecilie Manz

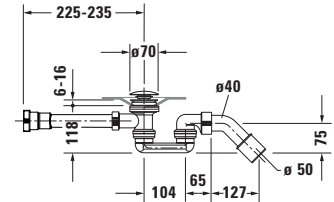
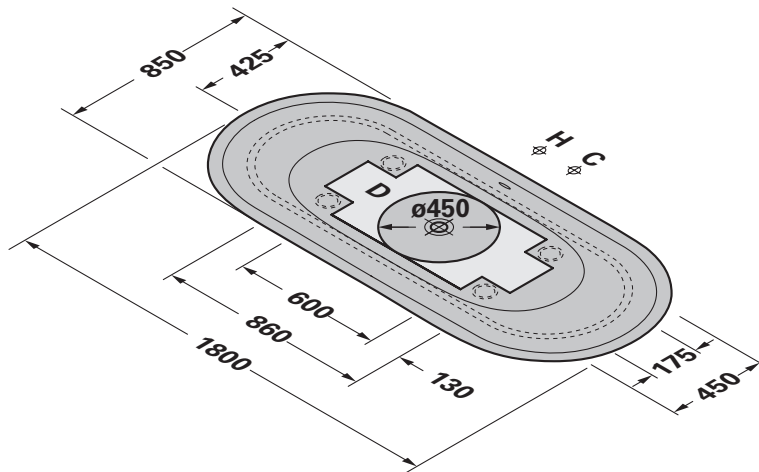

Siphon for bathtub # 700434

- H Hot water connection
- C Cold water connection
- D Drain connection

### Technical specifications

| Net weight<br>kg | Floor load<br>kg/m <sup>2</sup> | Shipping weight<br>kg | Shipping dimensions<br>l x w x h (cm) | Water inlet OD,<br>Base inlet OD | Whirlsystem | Model-No.           |
|------------------|---------------------------------|-----------------------|---------------------------------------|----------------------------------|-------------|---------------------|
| 133,0            | 291                             | 197,0                 | 200 x 100 x 85                        | -                                |             | 700434 00 0 00 0000 |

**DURAVIT AG**  
P.O. Box 240  
Werderstr. 36  
78132 Hornberg  
Germany  
Phone +49 78 33 70 0  
Fax +49 78 33 70 289  
info@duravit.com  
www.duravit.com

