

## Seria Rols

### Drzwi wnękowe / Kabina prostokątna

Instrukcja montażu  
Installation instructions  
Montážní návod

Zeskanuj kod  
i zobacz instrukcję  
montażu na

YouTube

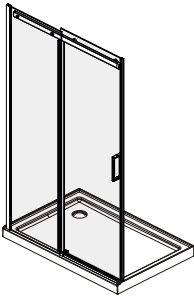

**KAEX.2612** - str. 4

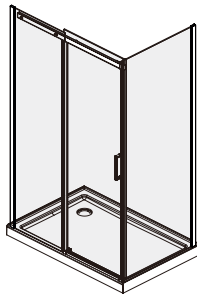

**KAEX.2606** - str. 10



#### Caution

Możliwość montażu na płytkach lub na brodziku. Wymagana szerokość rantu brodzika lub szerokość płytki: minimum 80mm.

Can be installed on tiles or on a shower tray. Required width of the shower tray edge or tile width: minimum 80mm.

Lze namontovat na dlaždice nebo na sprchovou vaničku. Požadovaná šířka okraje vaničky nebo šíře obkladu: minimálně 80 mm.



#### WAŻNE!

Przed rozpoczęciem montażu uważnie przeczytaj instrukcję. Zanim rozpoczniesz montaż dokładnie sprawdź swój produkt. Zamontowanie produktu z widoczną wadą powoduje utratę gwarancji.

#### UWAGA!

Aby zapobiec przeciekaniu wody silikon należy nałożyć na zewnętrznej stronie parawanu, a nie wewnątrz! Zachowaj tę instrukcję na przyszłość.

#### IMPORTANT!

Read all instructions carefully before starting the installation. Thoroughly inspect your product before proceeding with the installation. The warranty will be void if the product is installed with a conspicuous defect.

#### CAUTION!

To prevent leaks, silicone must be applied on the outside of the bathscreen and not on the inside! Save this manual for future reference.

#### DŮLEŽITÉ!

Před zahájením montáže si pozorně přečtěte návod. Před zahájením montáže zkontrolujte důkladně výrobek.

Namontování výrobku s viditelnou vadou způsobí ztrátu záruky.

#### POZOR!

Pro zabránění protékání vody, naneste silikon na vnější, nikoli vnitřní stranu zástěny! Tento návod si uschovejte pro budoucí použití.

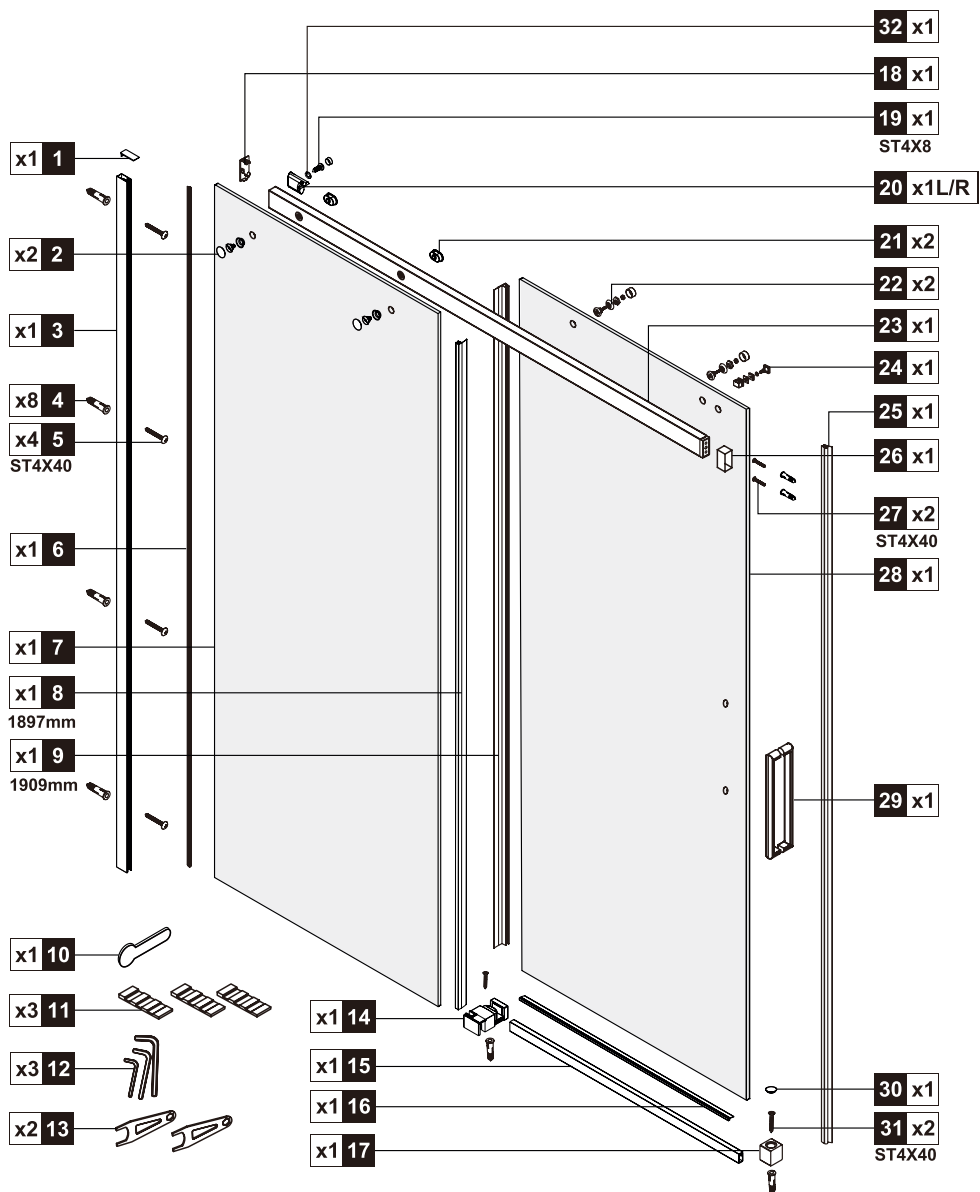

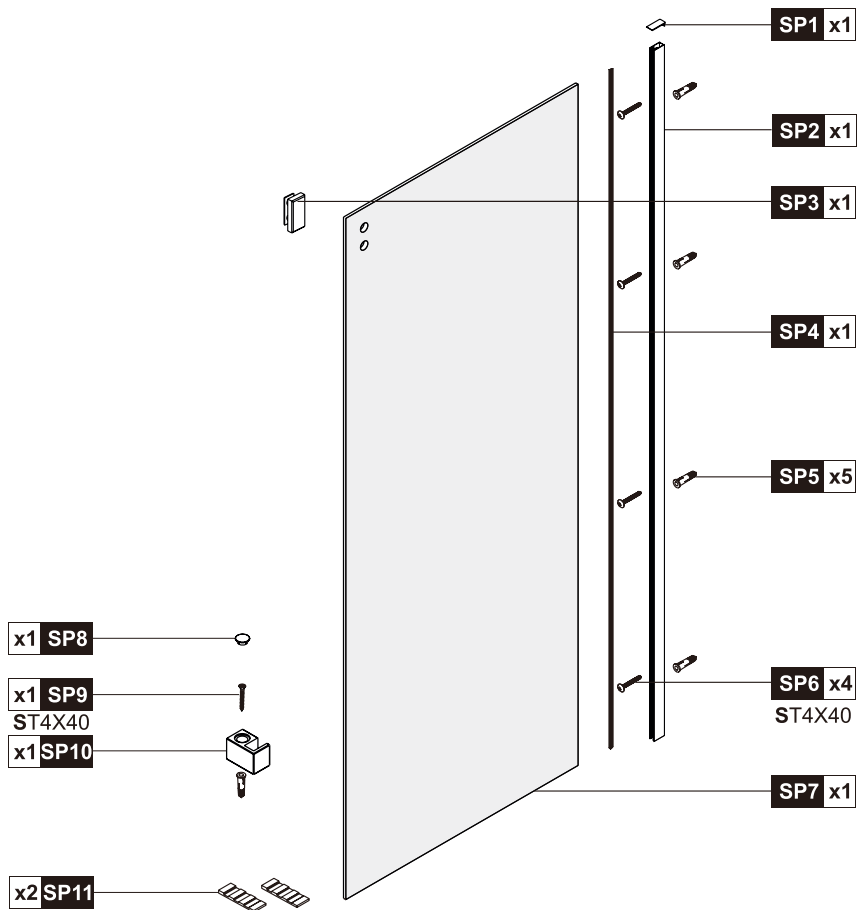

Przekrój / Cross-section / Průřez

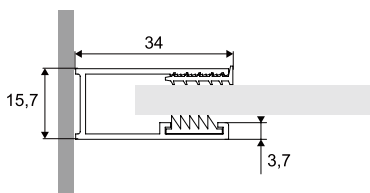

Przekrój profilu ścianki  
Wall profile cross-section  
Sténové profily průřez

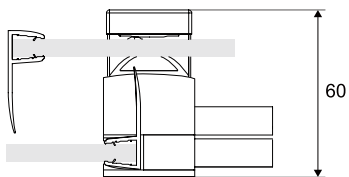

Przekrój dolnego systemu przesuwnego  
Cross-section of bottom sliding system  
Průřez spodním posuvným systémem

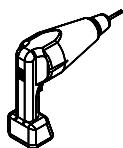

WIERTARKA

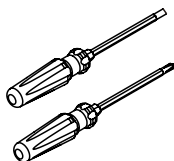

ŚRUBOKRĘT

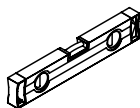

POZIOMICA

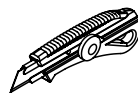

NÓŻ



SILIKON

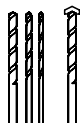

WIERTŁO: 1/8", 3/16" ET 1/4"  
\*WIERTŁA MURARSKIE

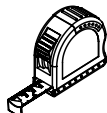

TAŚMA MIERNICZA



KĄTOWNICA



OLÓWEK



MŁOTEK

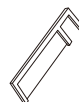

PIŁA

**A** 01 **KAEX.2612**

1000mm (970mm~1000mm)  
1200mm (1170mm~1200mm)  
1300mm (1270mm~1300mm)  
1400mm (1370mm~1400mm)  
1600mm (1570mm~1600mm)  
1800mm (1770mm~1800mm)

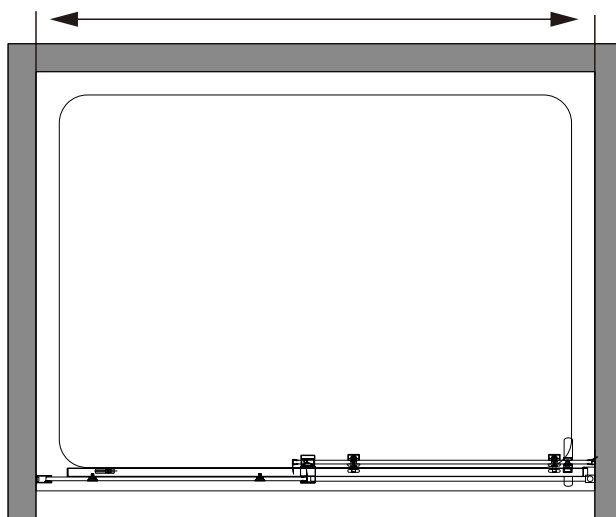

**A** 02

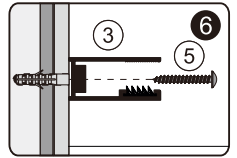
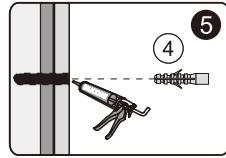
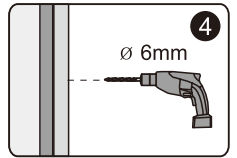
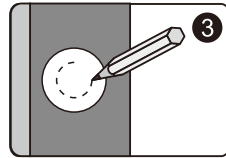
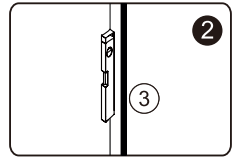
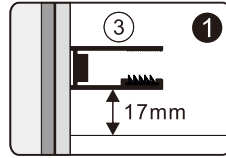
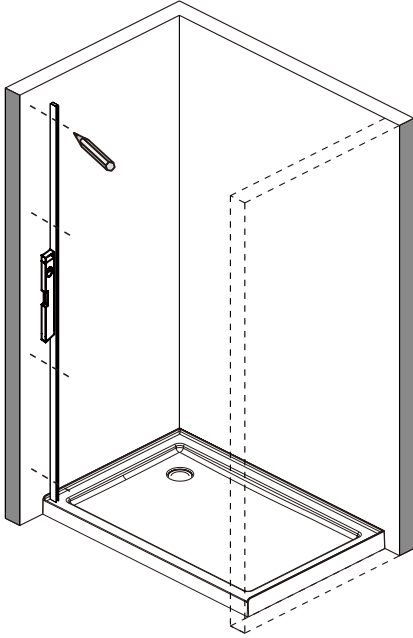

**A** 03

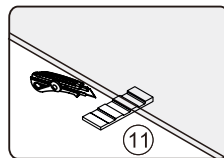
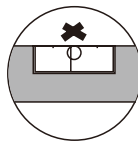
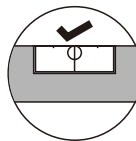
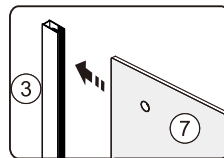
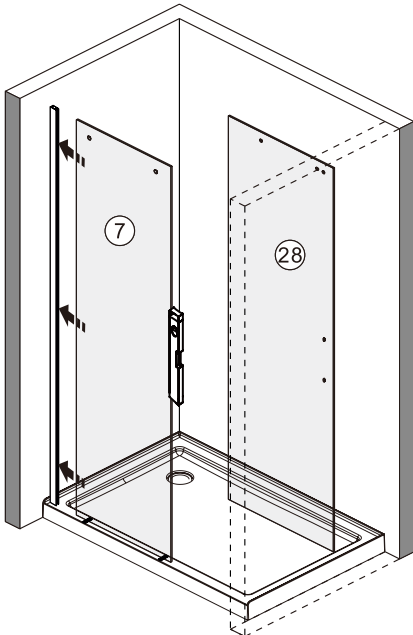

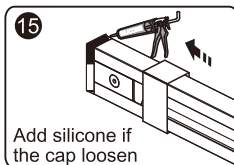
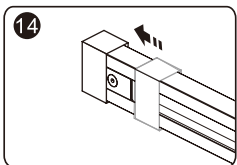
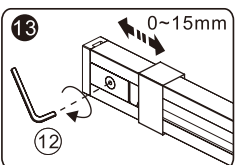
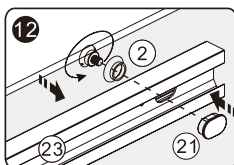
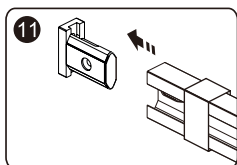
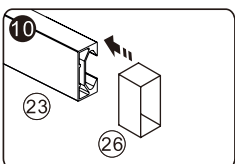
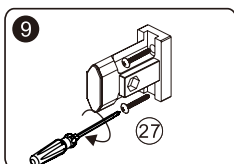
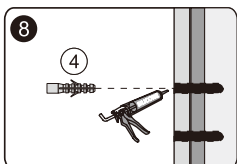
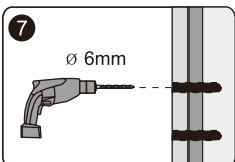
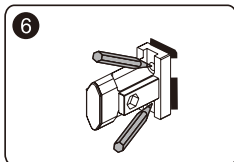
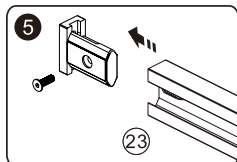
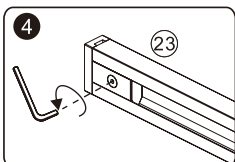
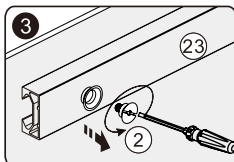
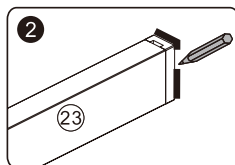
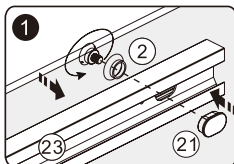
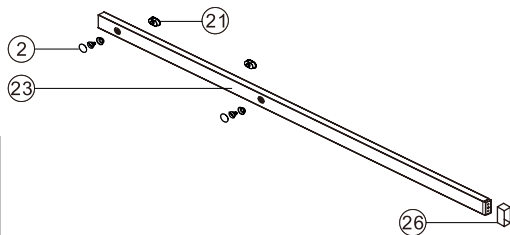
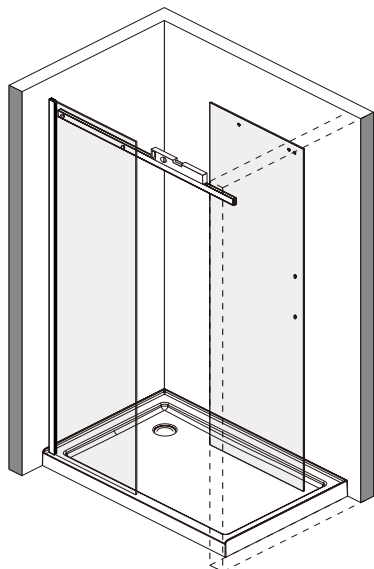

Add silicone if the cap loosens

**A** 05

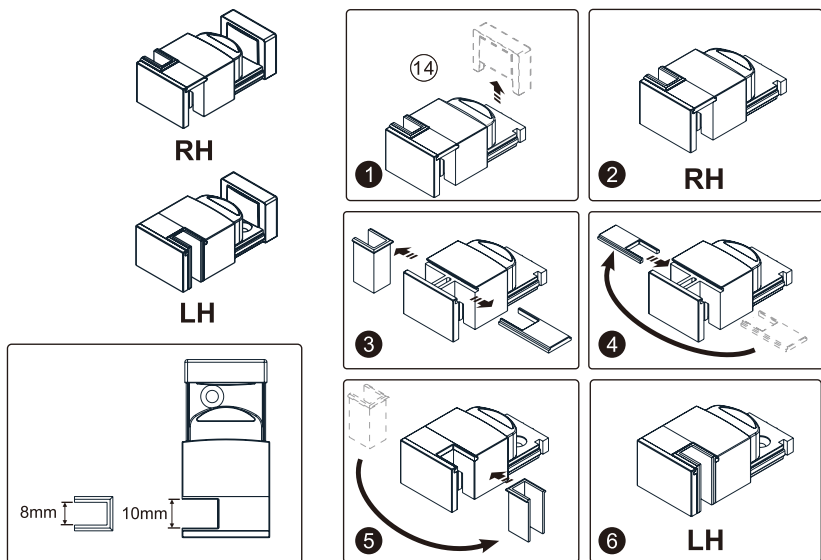

**A** 06

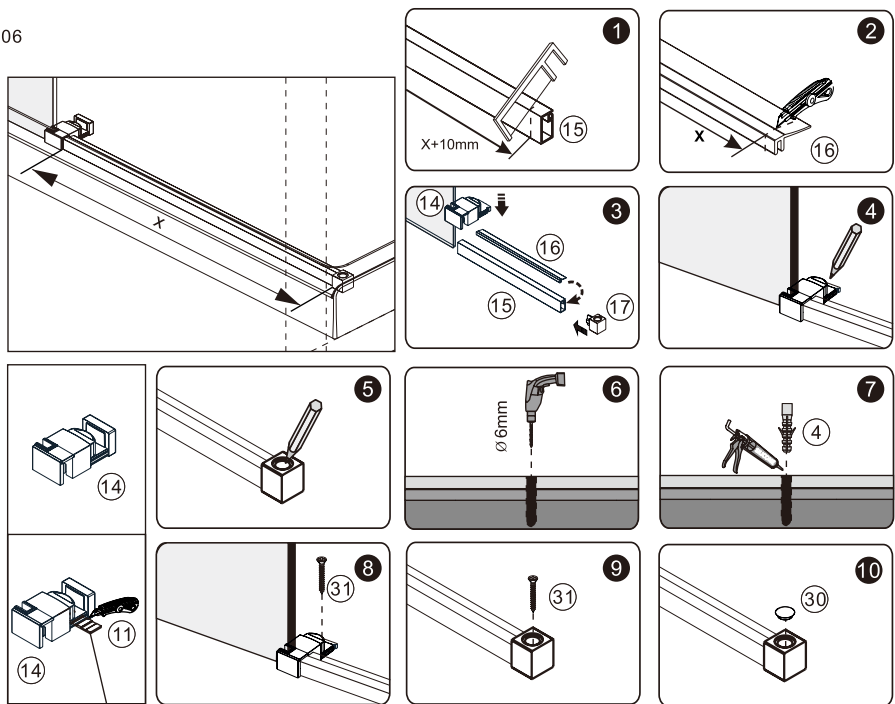

W przypadku, gdy poziom brodzika się obniża, aby zamontować prowadnik drzwi użyj klina pozycjonującego, aby zablokować go w pozycji poziomej.

**A**<sub>07</sub>

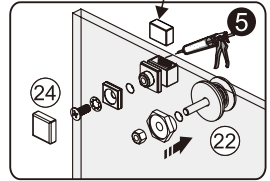
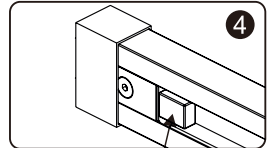
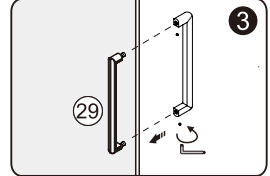
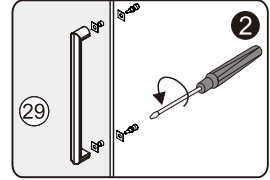
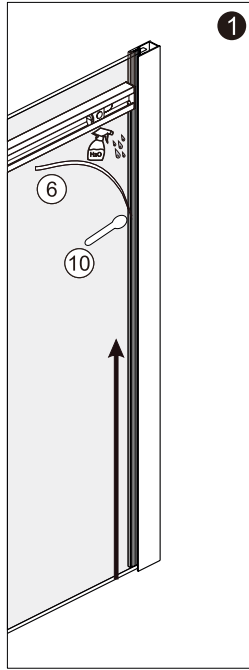
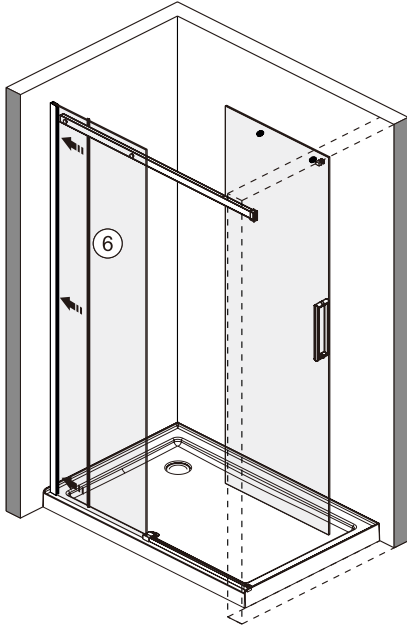

**A**<sub>08</sub>

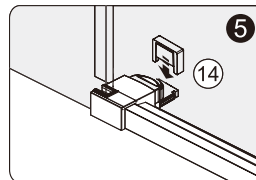
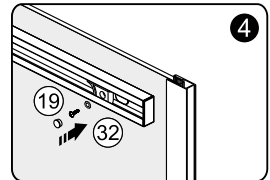
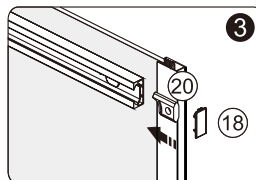
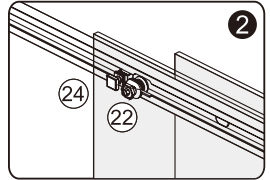
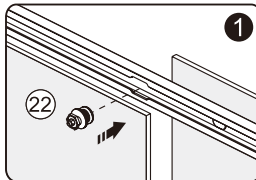
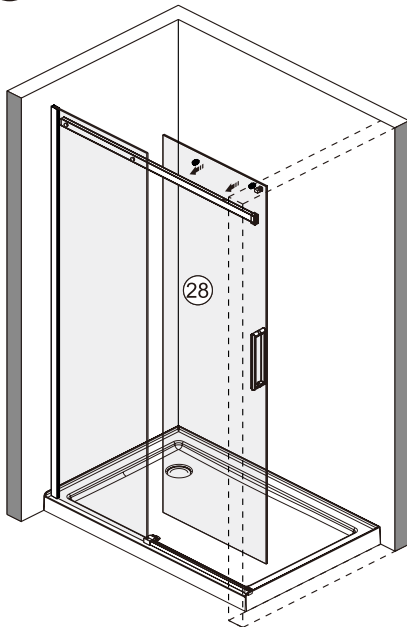



**A** 09

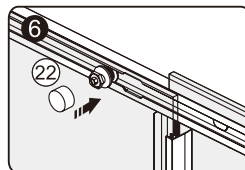
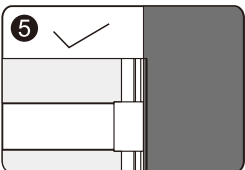
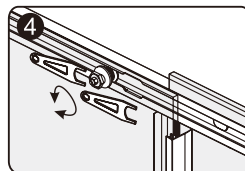
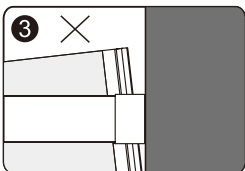
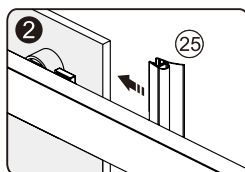
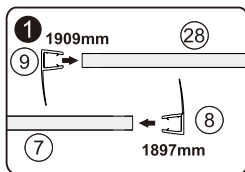
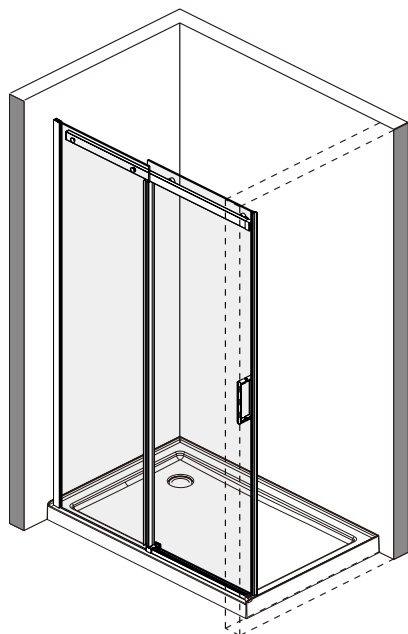

**A** 10

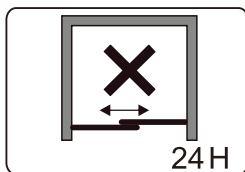
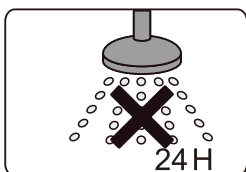
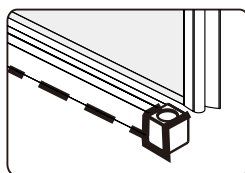
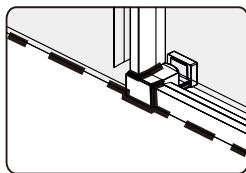
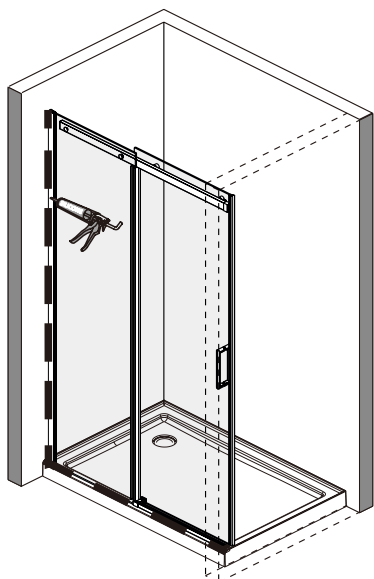

**B** 01 KAEX.2606

1000mm (983mm~1013mm)  
 1200mm (1183mm~1213mm)  
 1300mm (1283mm~1313mm)  
 1400mm (1383mm~1413mm)  
 1600mm (1583mm~1613mm)  
 1800mm (1783mm~1813mm)

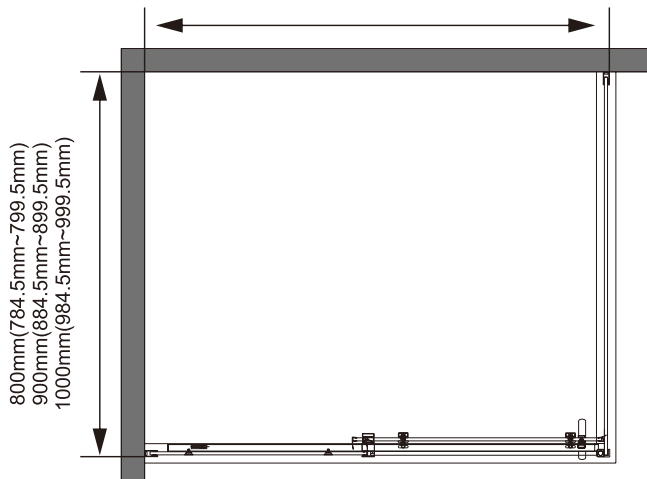

**B** 02

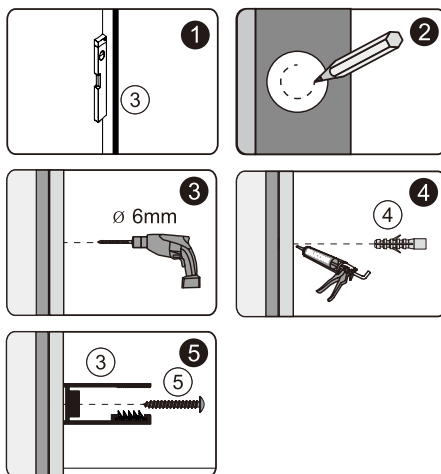
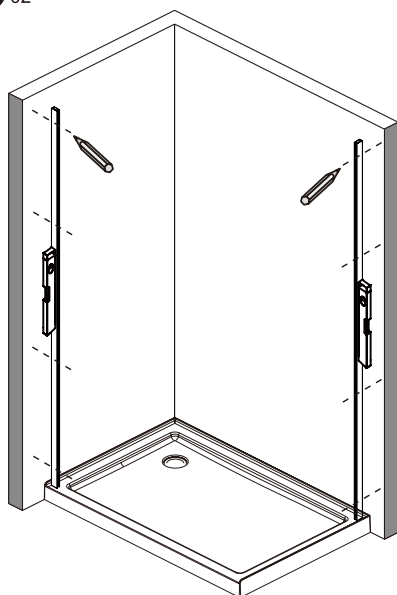

**B** 03

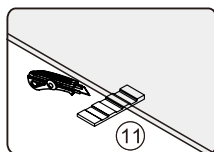
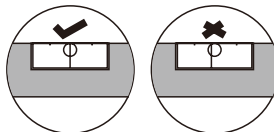
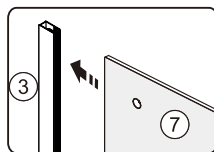
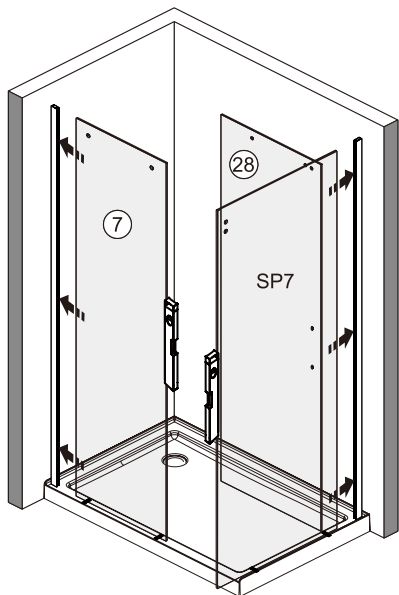

**B** 04

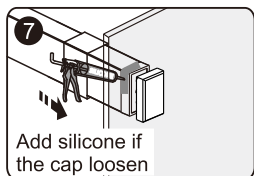
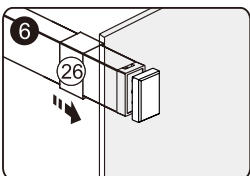
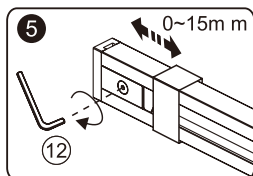
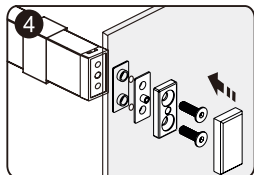
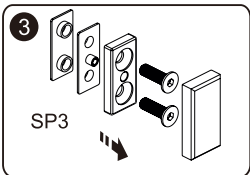
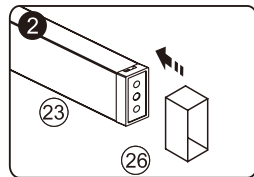
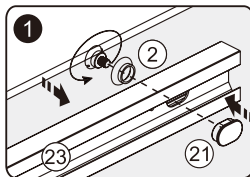
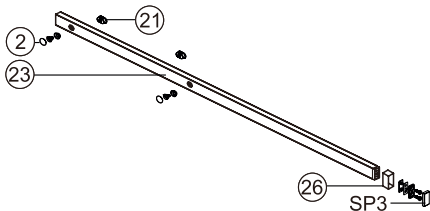
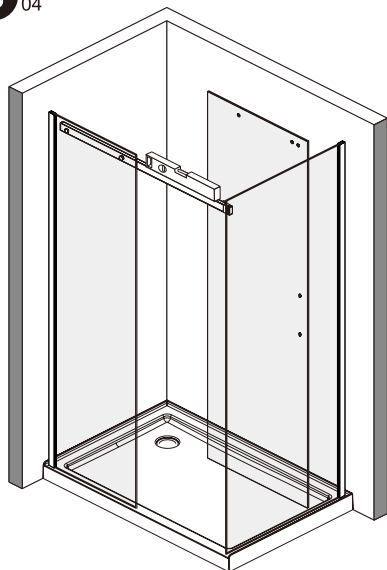

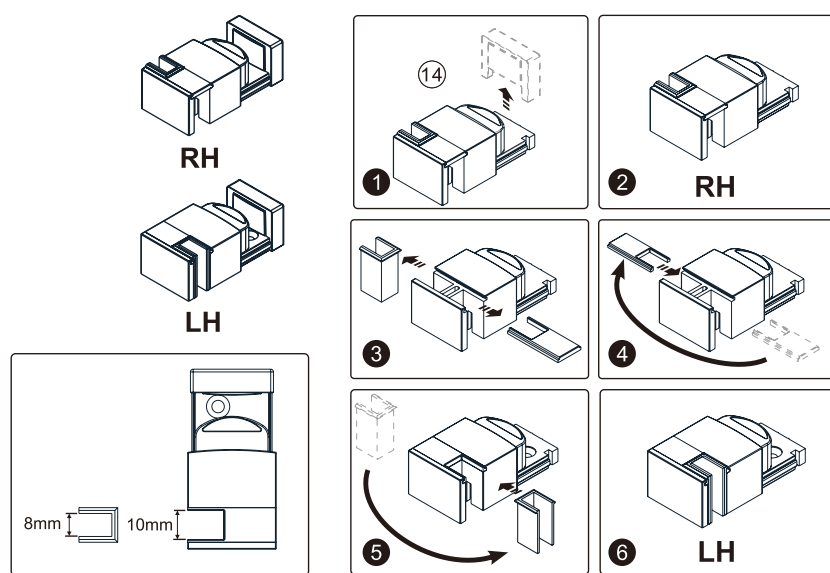
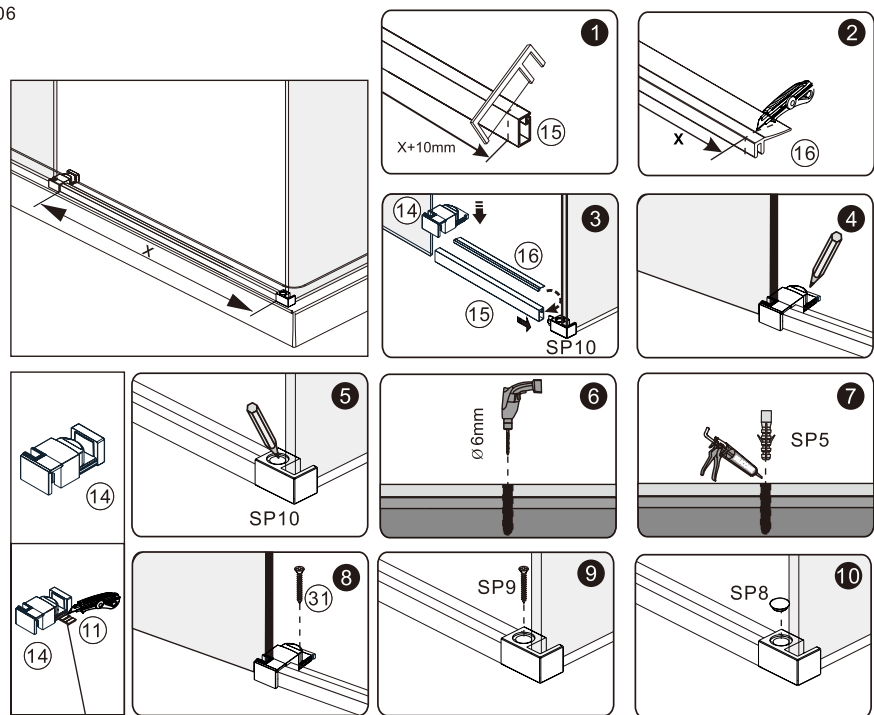
**B** 05**B** 06

W przypadku, gdy poziomy brodzik się obniży, aby zamontować prowadnik drzwi użyj klina pozycjonującego, aby zablokować go w pozycji poziomej.

**B** 07

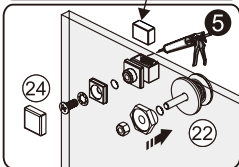
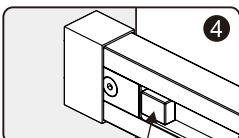
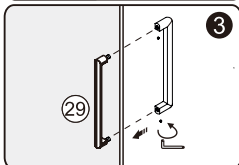
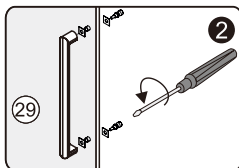
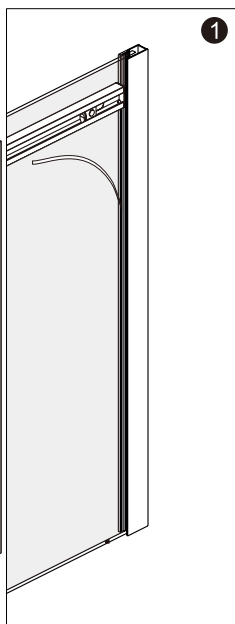
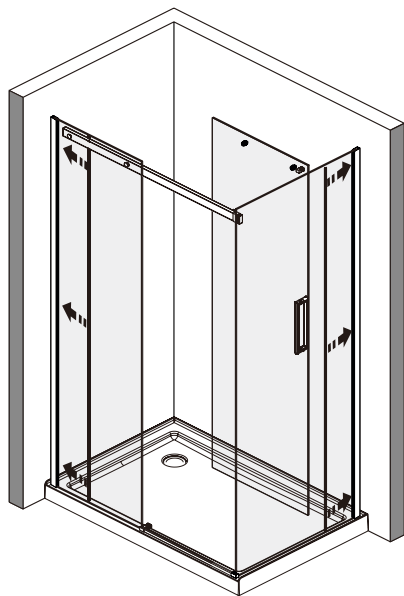

**B** 08

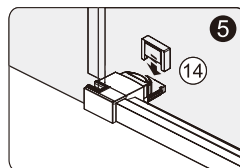
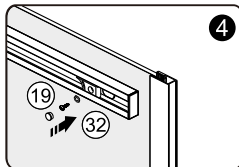
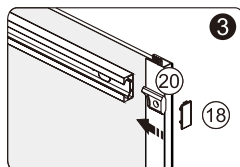
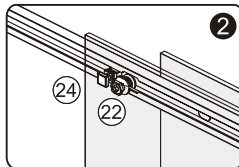
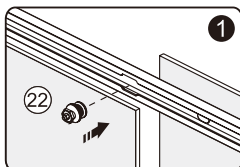
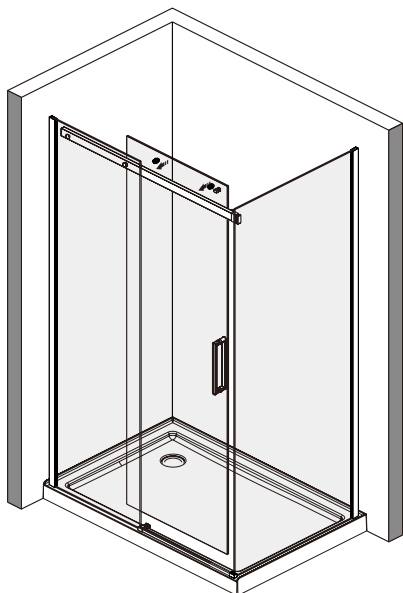

**B** 09

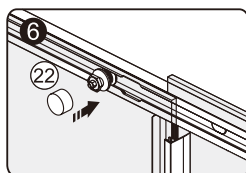
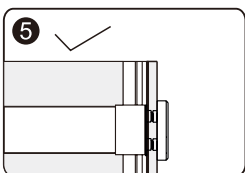
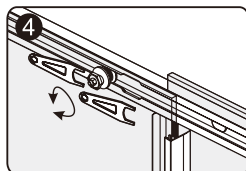
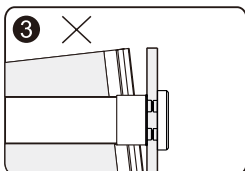
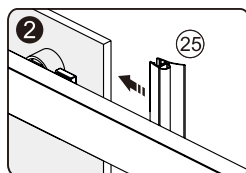
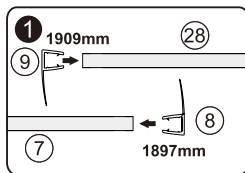
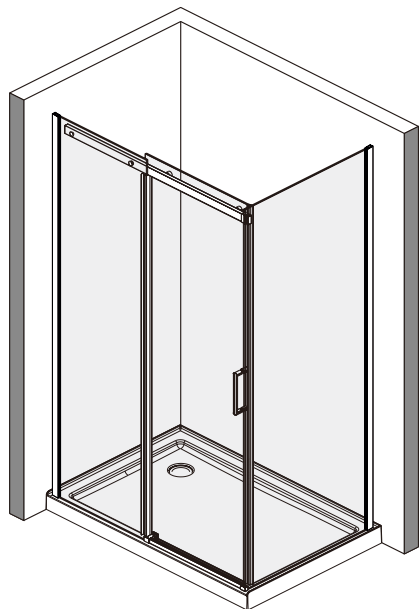

**B** 10

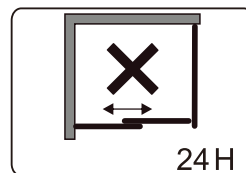
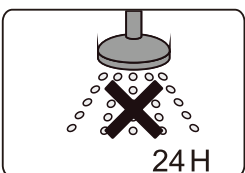
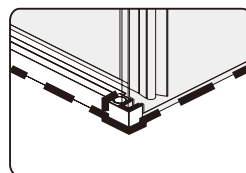
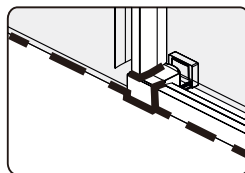
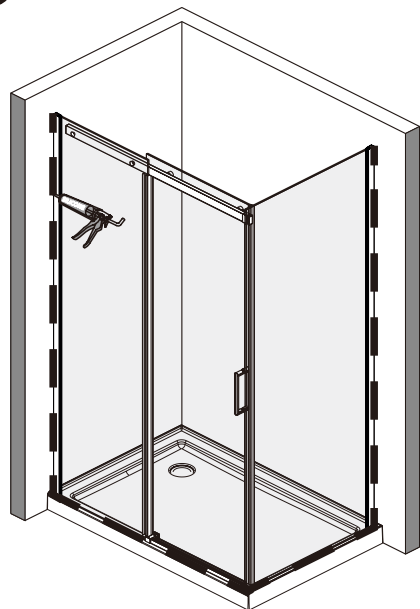

## CZYSZCZENIE I KONSERWACJA

Aby utrzymać powierzchnię szkła kabiny w nienagannym stanie przez wiele miesięcy, warto zastosować się do poniższych wskazówek:

- Po każdej kąpieli należy spłukać szkło wodą a następnie ściągaczką do szyb lub miękką tkaniną usunąć wodę z powierzchni.
- Nie należy do czyszczenia kabiny używać środków zawierających kwasy, aceton, formaldehydy czy benzynę

## GWARANCJA

Warunki gwarancji dostępne na stronie: <http://www.excellent.com.pl/gwarancja>

|   |                           |  |
|---|---------------------------|--|
|  | <b>5 LAT</b><br>GWARANCJI | Kabiny Excellent – producent zapewnia 5 lat gwarancji.<br>Nie dotyczy elementów podlegających naturalnemu zużyciu w trakcie eksploatacji takich jak: uszczelki oraz powłoka Clean Control. |
|---|---------------------------|--|

## GWARANCJA NIE OBEJMUJE:

- Uszkodzeń mechanicznych zawinionych przez sprzedawcę, instalatora lub użytkownika końcowego
- Wad i uszkodzeń powstałych na skutek niewłaściwego stosowania.
- Wad i uszkodzeń powstałych na skutek wadliwego zainstalowania wyrobu (niezgodnych z powyższą instrukcją oraz sztuką budowlaną).
- Przedwczesnego zużycia się elementów spowodowanym niewłaściwym montażem.
- Uszkodzeń powstałych na skutek osadzania się kamienia lub niewłaściwego czyszczenia.

Produkt spełnia wymagania normy: PN-EN 14428+A1:2018

## CLEANING AND MAINTENANCE

To keep the glass surface of your shower enclosure in perfect condition for many months, follow these tips:

- After each bath, rinse the glass with water and then remove the water from the surface with a squeegee or a soft cloth.
- Do not use agents containing acids, acetone, formaldehyde or gasoline to clean the product.

## WARRANTY

Warranty conditions available on website: <http://www.excellent.com.pl/gwarancja>

|   |                           |   |
|---|---------------------------|---|
|  | <b>5 YEAR</b><br>WARRANTY | Shower enclosure Excellent - producer provides 5 year warranty.<br>It does not apply to elements subject to natural wear during product shelf life, such as: gaskets and Clean Control surface. |
|---|---------------------------|---|

## THE WARRANTY DOES NOT COVER:

- Mechanical damage caused by the seller, installer or end user
- Defects and damage caused by improper use
- Defects and damages resulting from improper installation of the product (inconsistent with the above instructions and construction practice)
- Premature wear of components due to incorrect assembly
- Damage caused by limescale build-up or improper cleaning

The product meets the requirements of the standard: PN-EN 14428 + A1: 2018

## ČIŠTĚNÍ A ÚDRŽBA

Abyste udrželi skleněný povrch vašeho stánku v perfektním stavu po mnoho měsíců, dodržujte tyto tipy:

- Po každé koupeli opláchněte sklenici vodou a poté vodu z povrchu odstraňte stěrkou na okna nebo měkkým hadříkem.
- K čištění kabiny nepoužívejte prostředky obsahující kyseliny, aceton, formaldehyd nebo benzin.

## ZÁRUKA

Záruční podmínky jsou k dispozici na: <http://www.excellent.com.pl/gwarancja>

|   |                        |  |
|---|------------------------|--|
|  | <b>5 LET</b><br>ZÁRUKY | Sprchové kabiny Excellent – výrobce poskytuje záruku 5 let. Neplatí pro díly podléhající přirozenému opotřebení při používání, jako jsou: těsnění a nátěr Clean Control. |
|---|------------------------|--|

### ZÁRUKA SE NEVZTAHUJE NA:

- Mechanické poškození způsobené prodejcem, montérem nebo koncovým uživatelem
- Vady a poškození způsobené nesprávným používáním
- Vady a poškození vyplývající z nesprávné instalace výrobku (v rozporu s výše uvedenými pokyny a konstrukční praxí)
- Předčasné opotřebení součástí v důsledku nesprávné montáže
- Poškození způsobené usazováním vodního kamene nebo nesprávným čištěním

Výrobek splňuje požadavky normy: PN-EN 14428 + A1: 2018

---

# EXCELLENT

Excellent SA  
32-003 Podłęże 662

Tel.: 12 657 18 87  
e-mail: [lazienki@excellent.com.pl](mailto:lazienki@excellent.com.pl)

[www.excellent.com.pl](http://www.excellent.com.pl)