

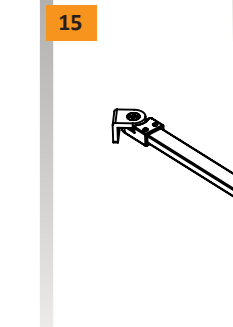

NEW MERANA

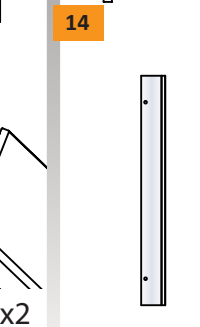

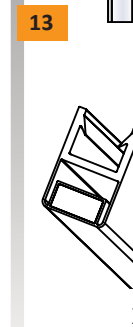
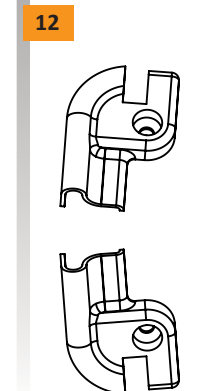
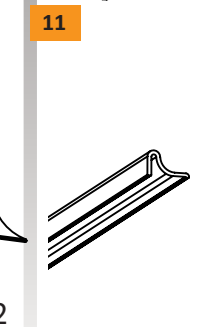
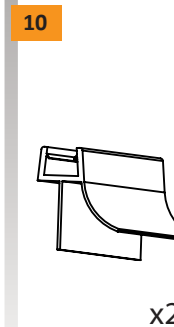
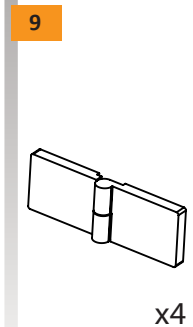
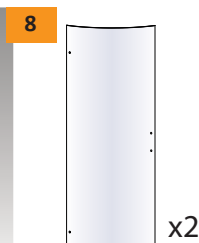
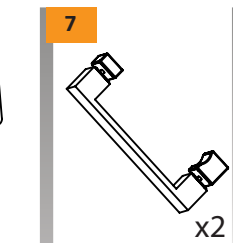
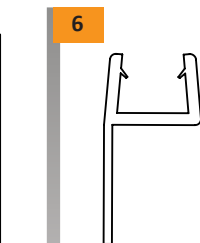
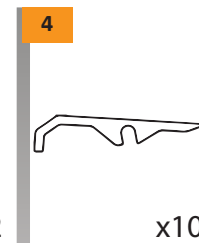
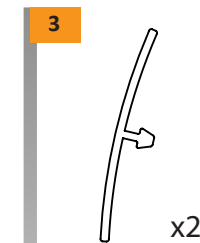
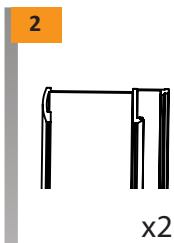
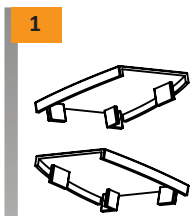
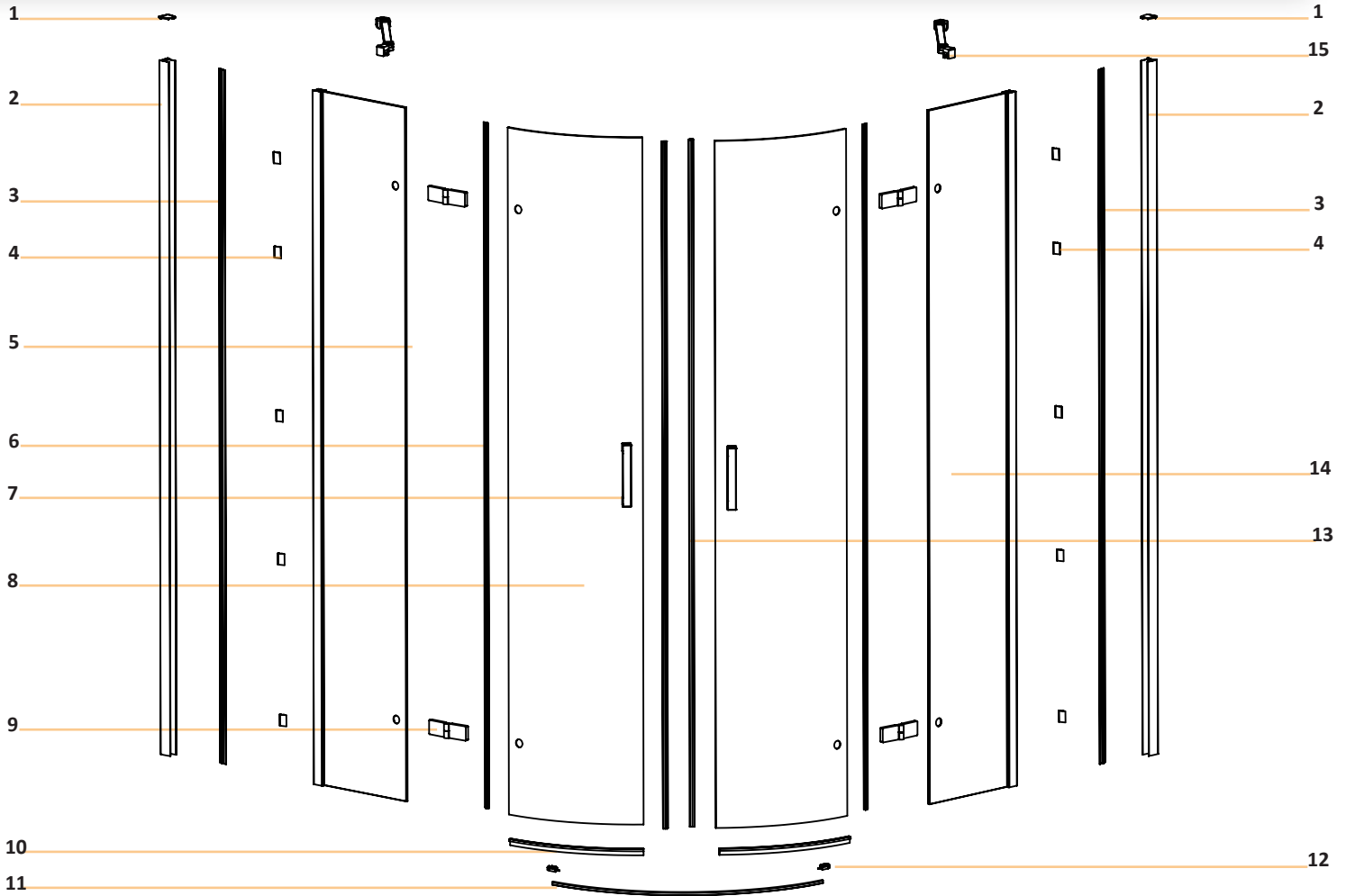
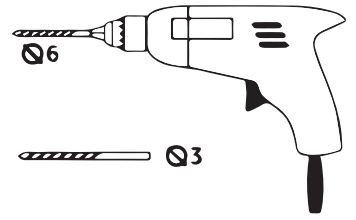
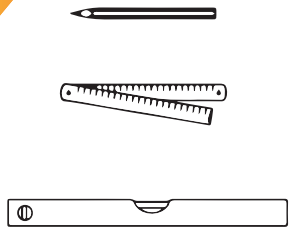

1

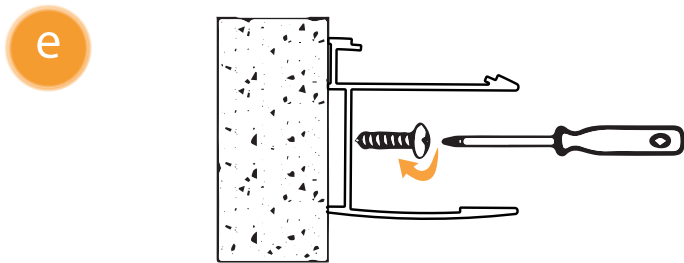
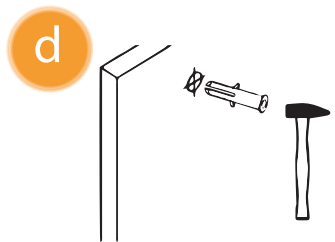
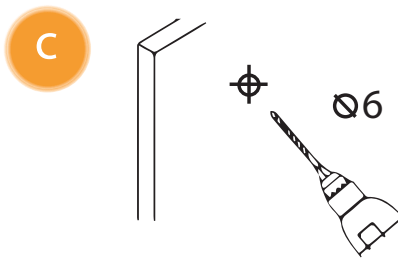
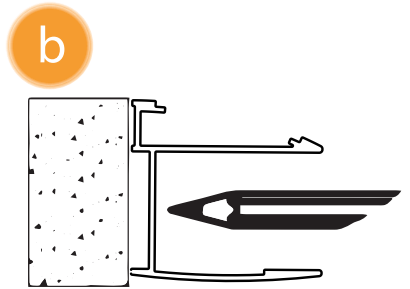
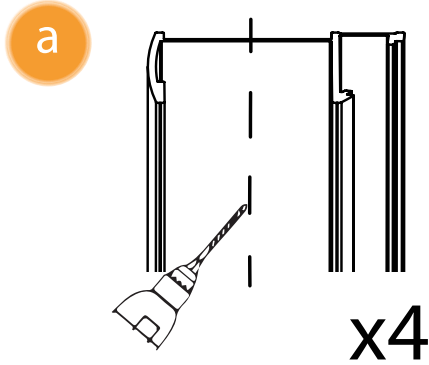
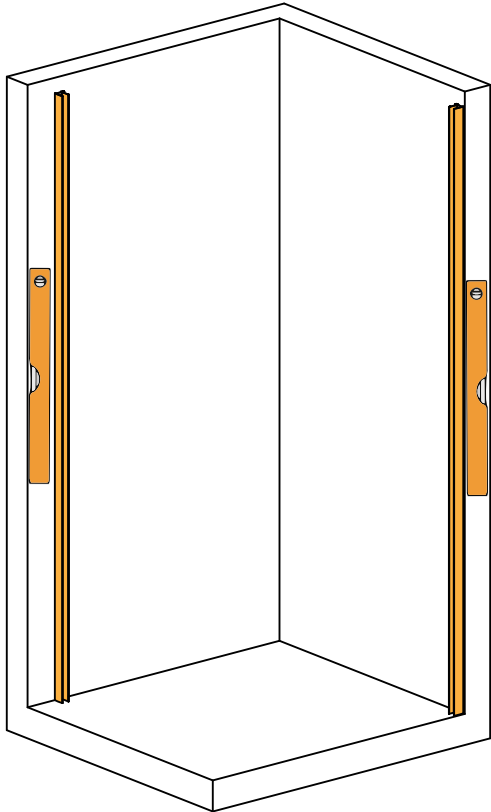

2

		A	B	C	D	H
K-0324	80x80x195	78,5-80	78,5-80	24,5	74	195
K-0325	90x90x195	88,5-90	88,5-90	34,5	74	195
K-0330	100x100x195	98,5-100	98,5-100	44,5	74	195

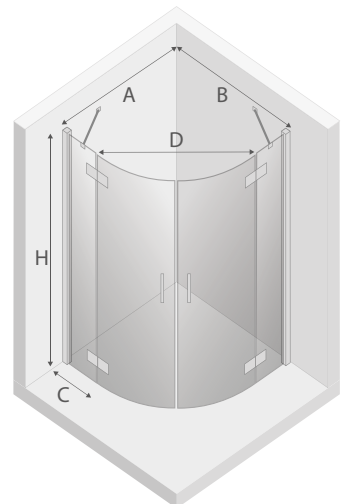

3

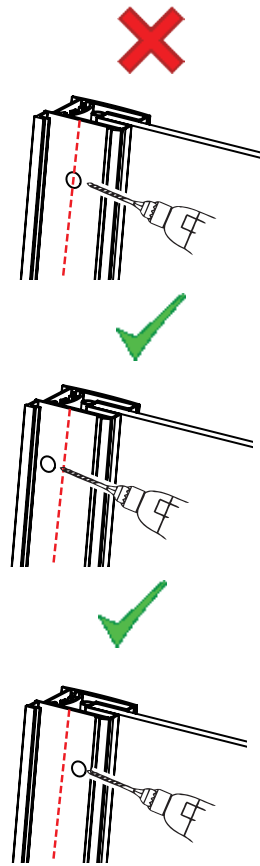
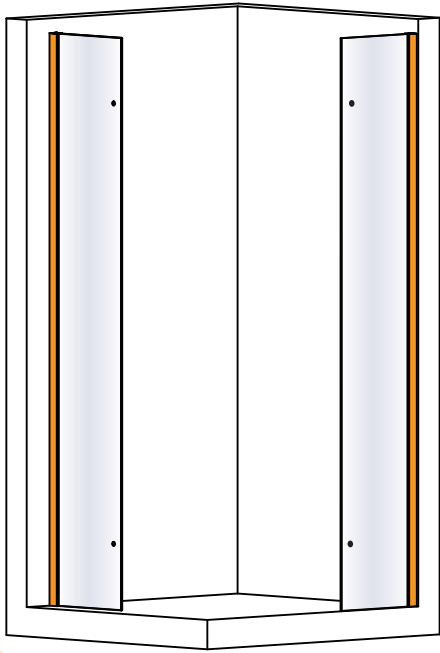

a

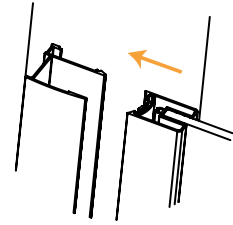

b

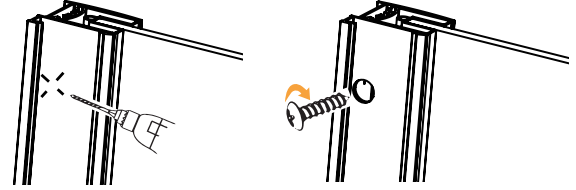

c

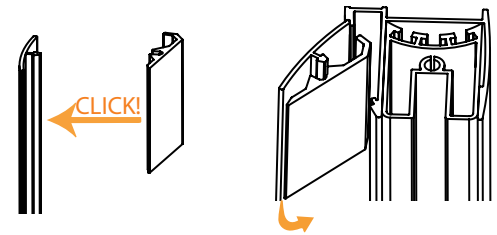

4

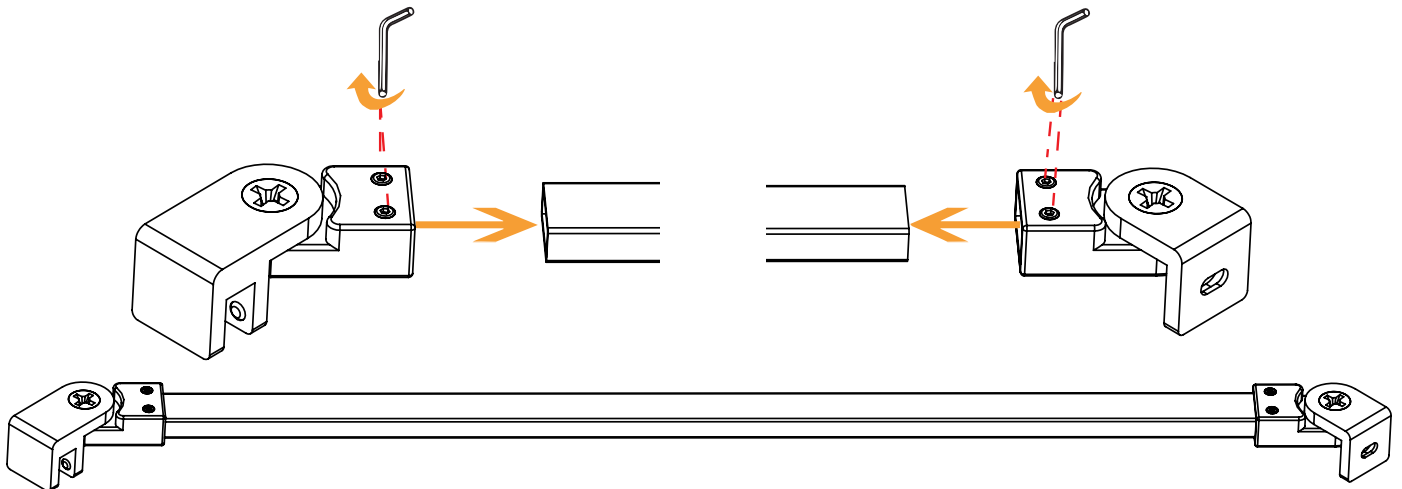
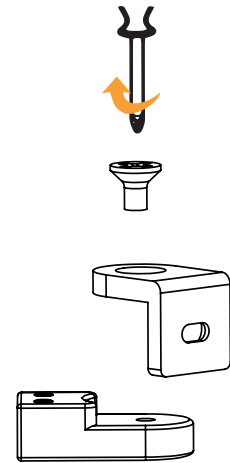
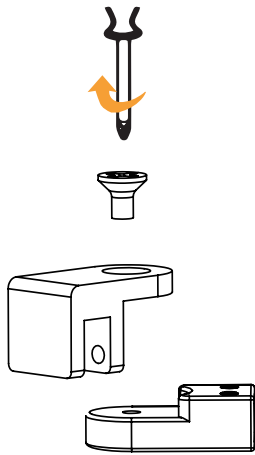

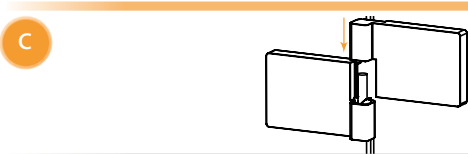
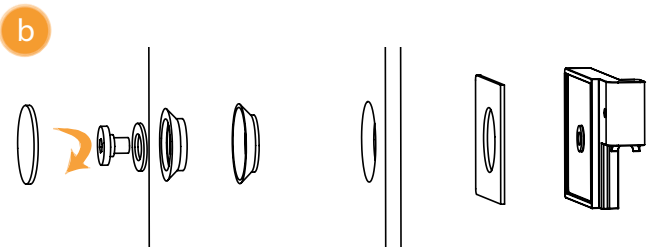
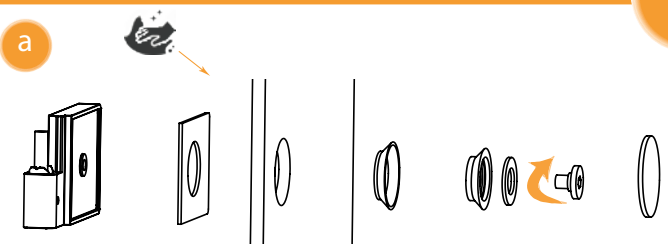
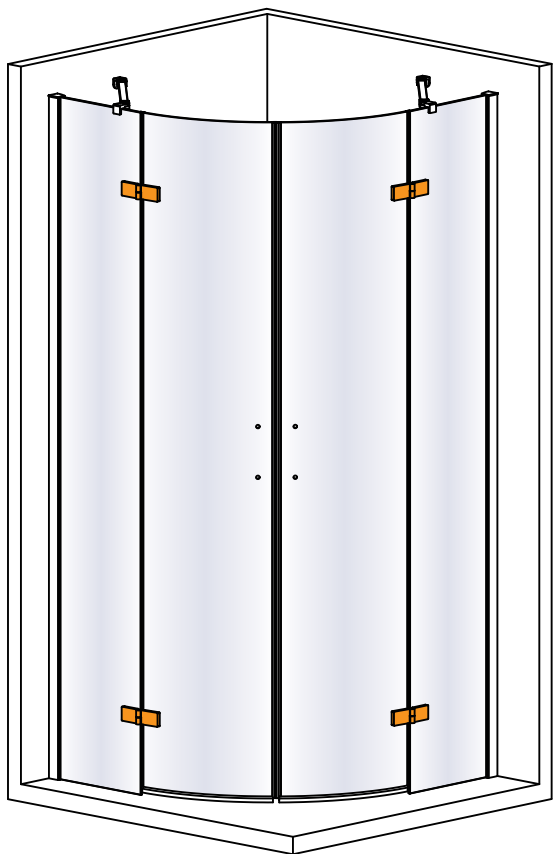
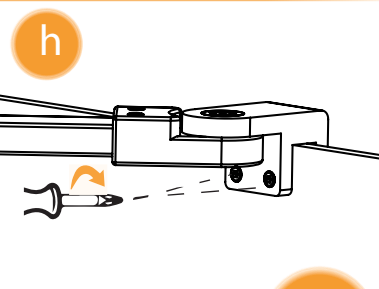
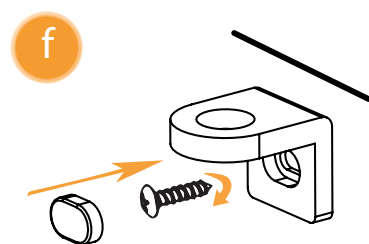
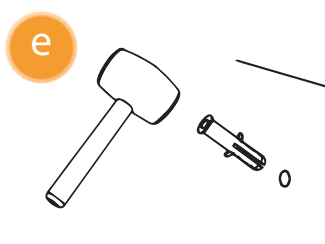
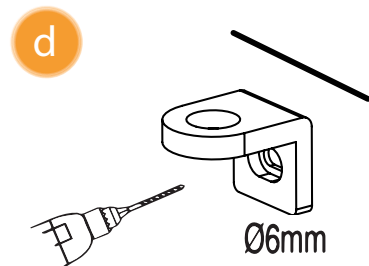
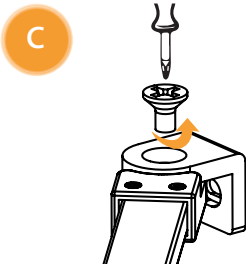
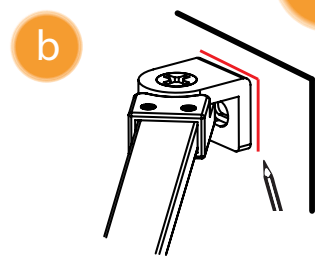
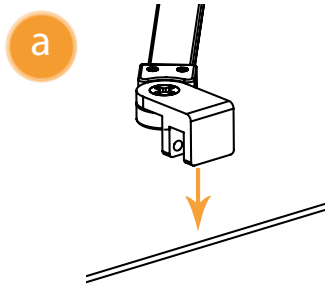
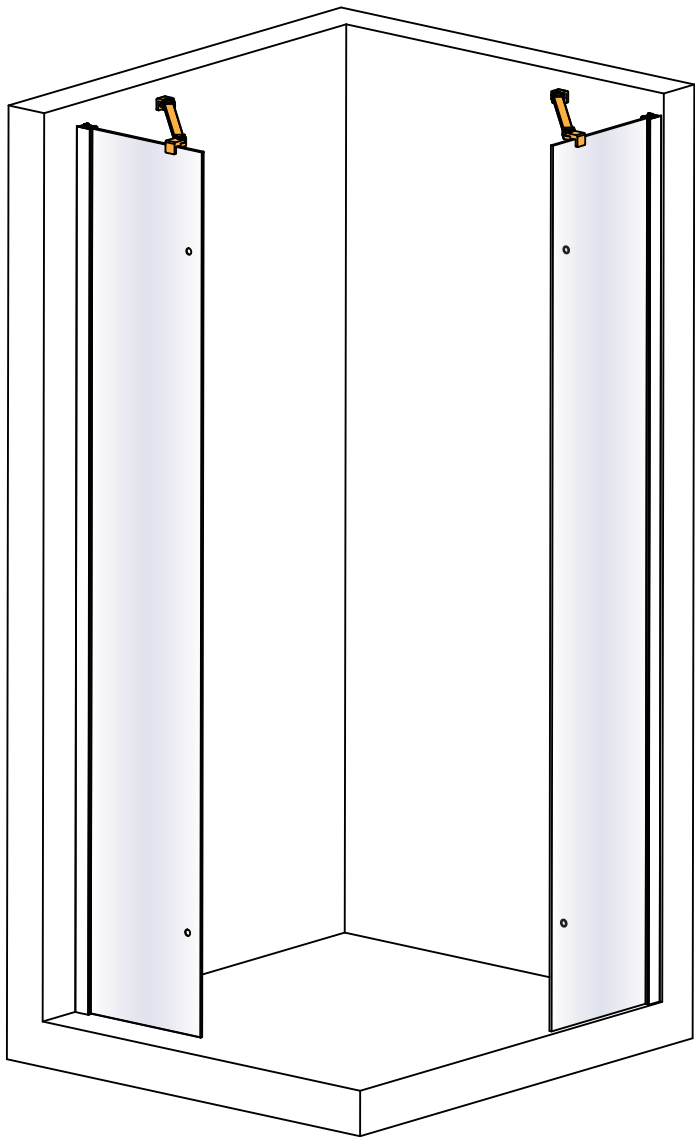

7

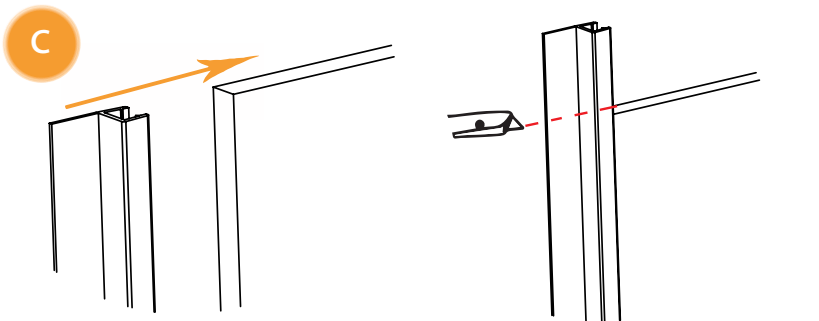
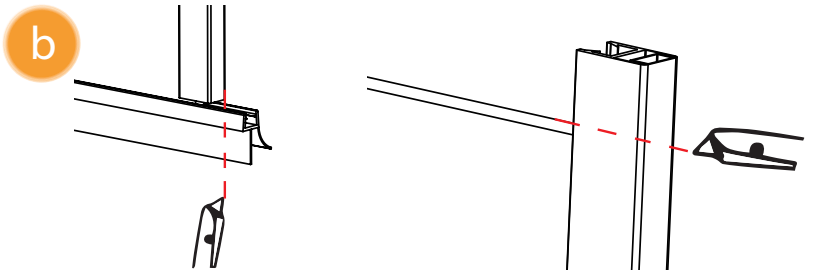
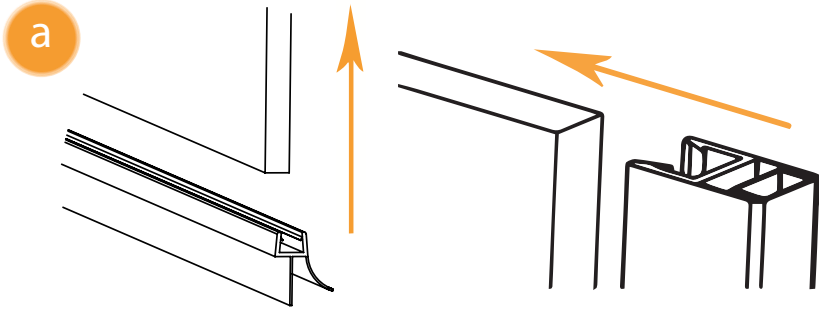
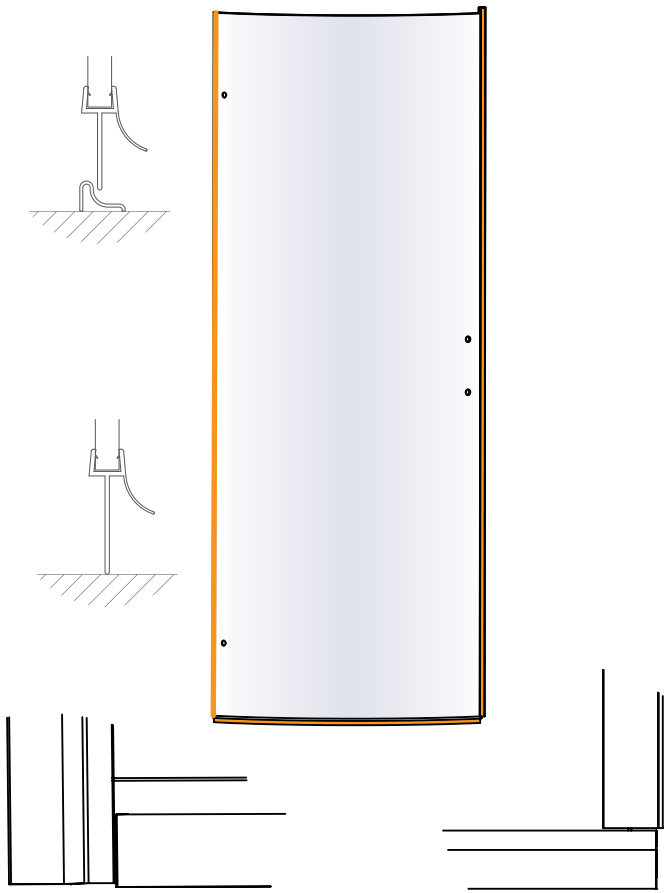

8

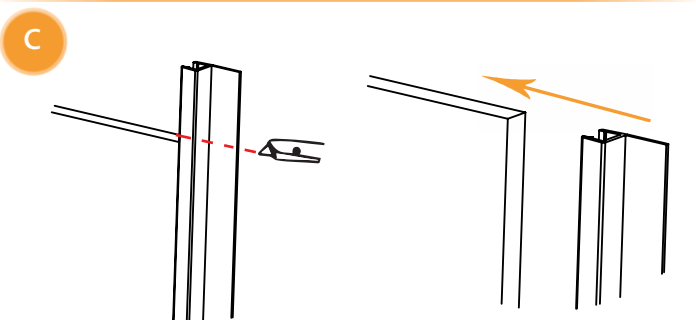
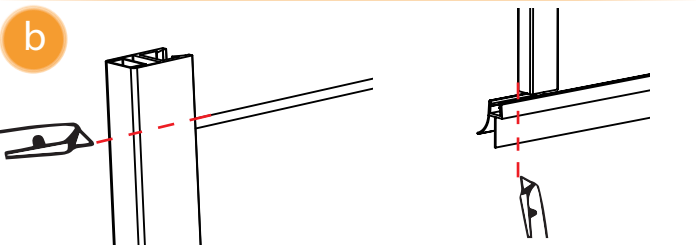
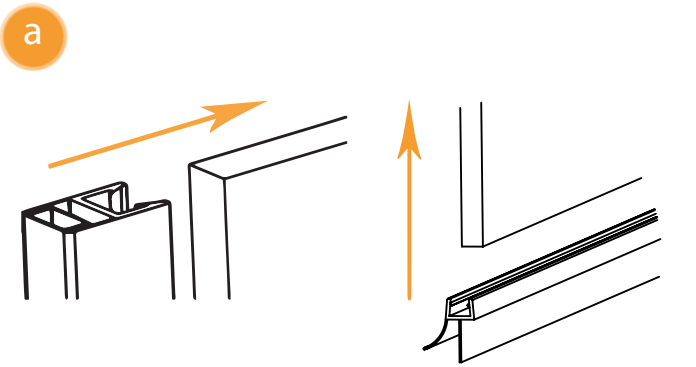
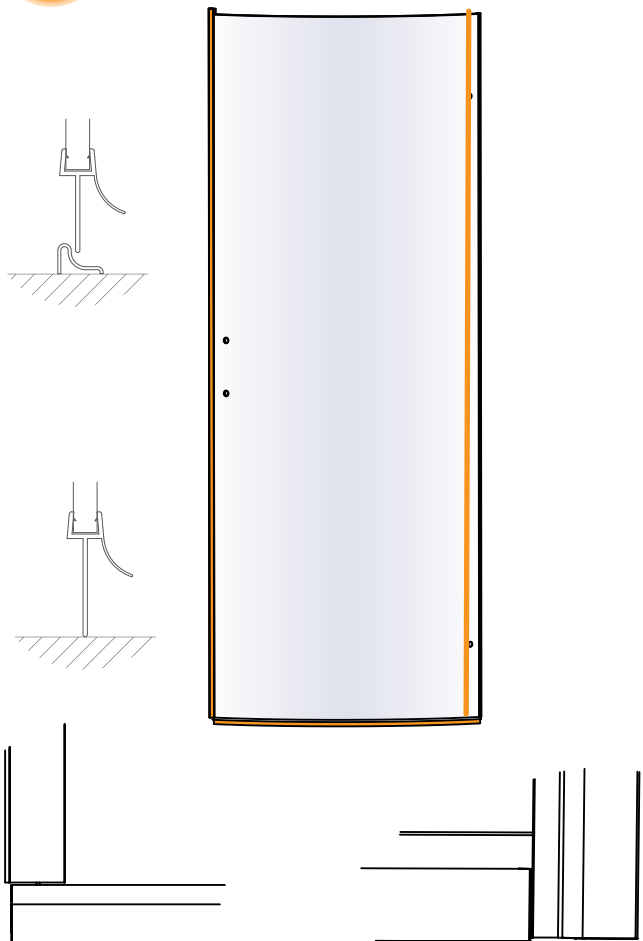

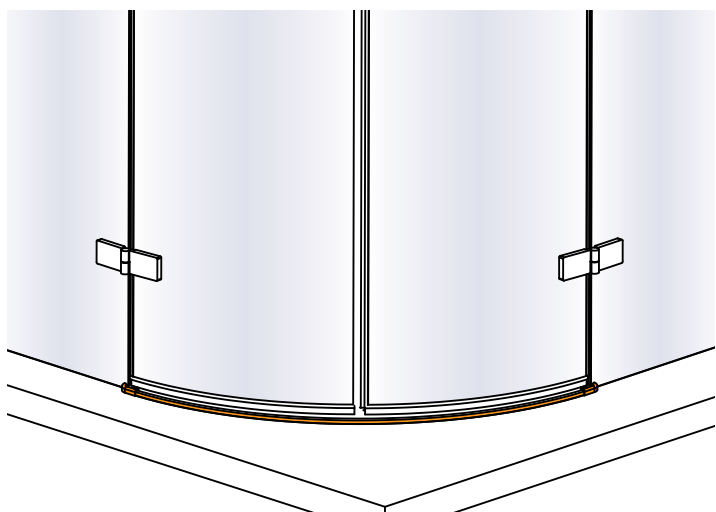
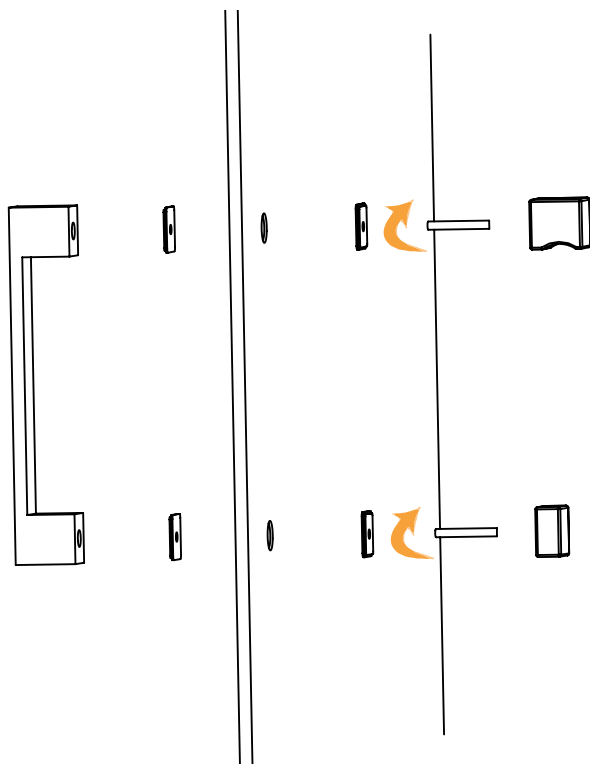
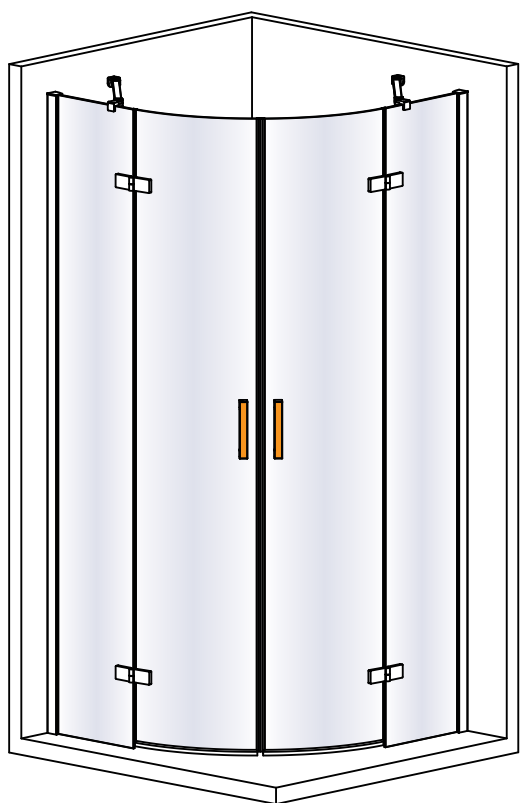

a

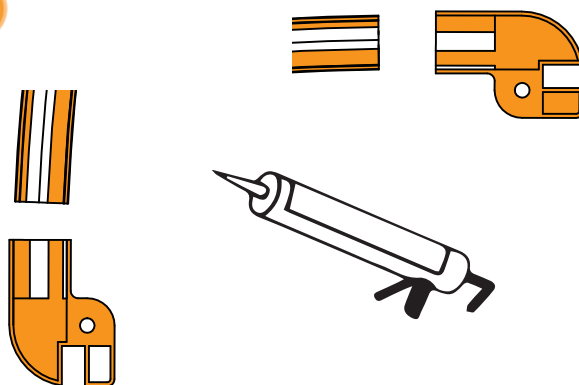

b

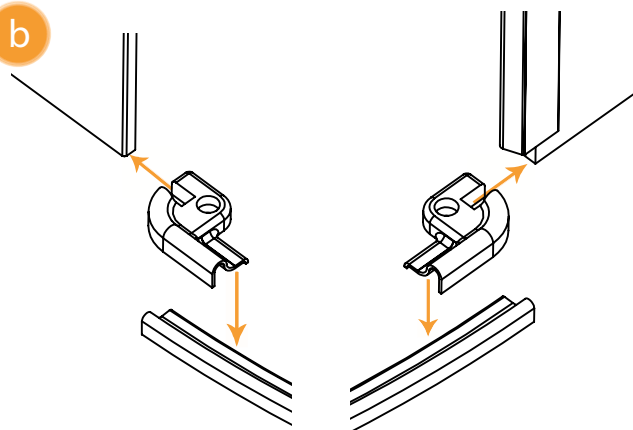

c

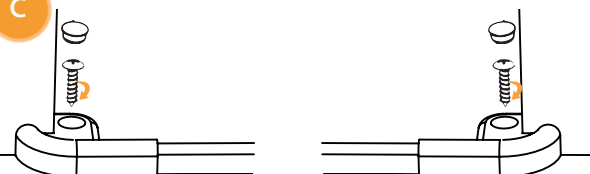

11

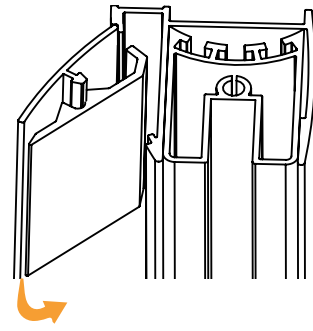
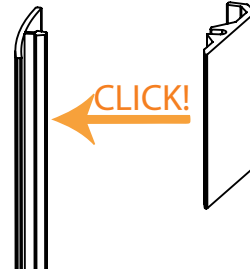
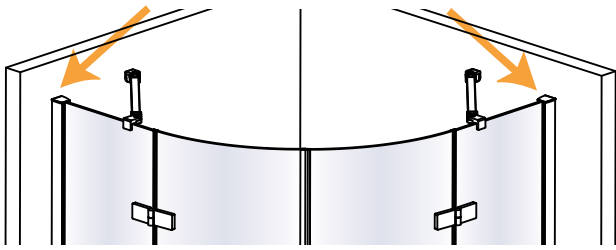

12

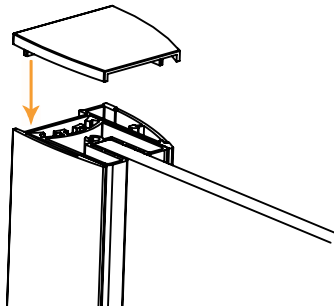

24H

