

# INSTALLATION MANUAL

MONTAGEANLEITUNG  
INSTRUCTIONS DE MONTAGE  
ISTRUZIONI PER IL MONTAGGIO

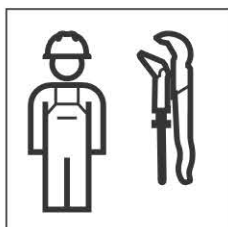



1

1

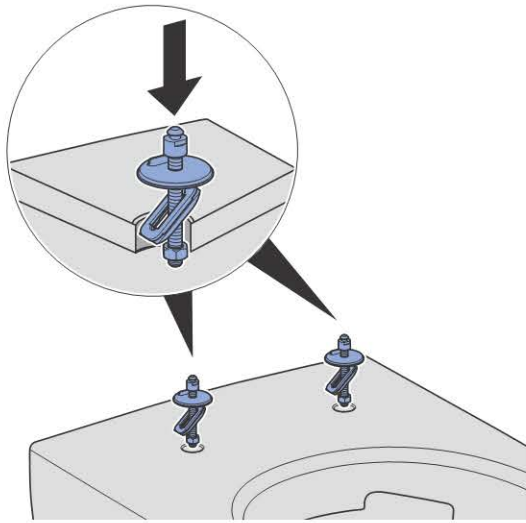

2

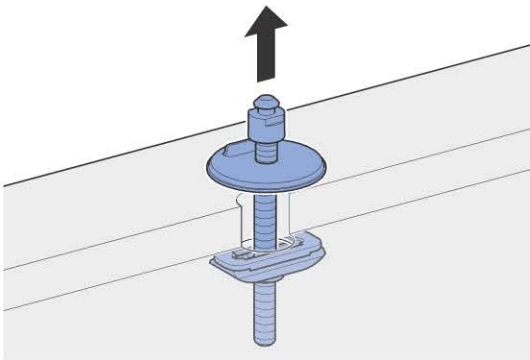

3

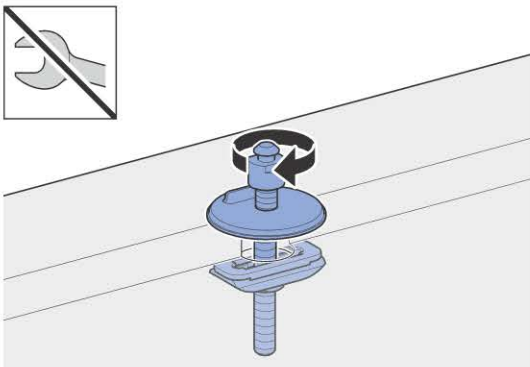

4

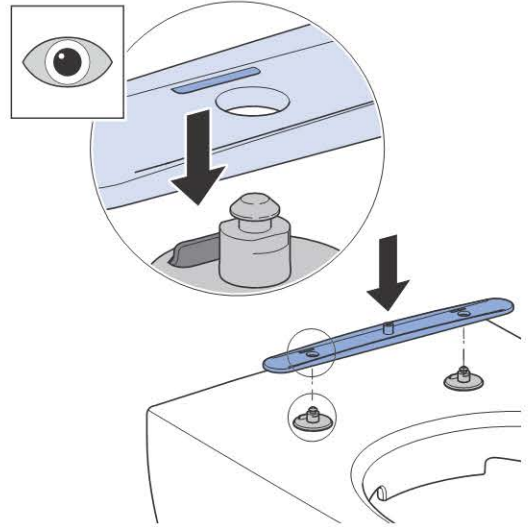

5

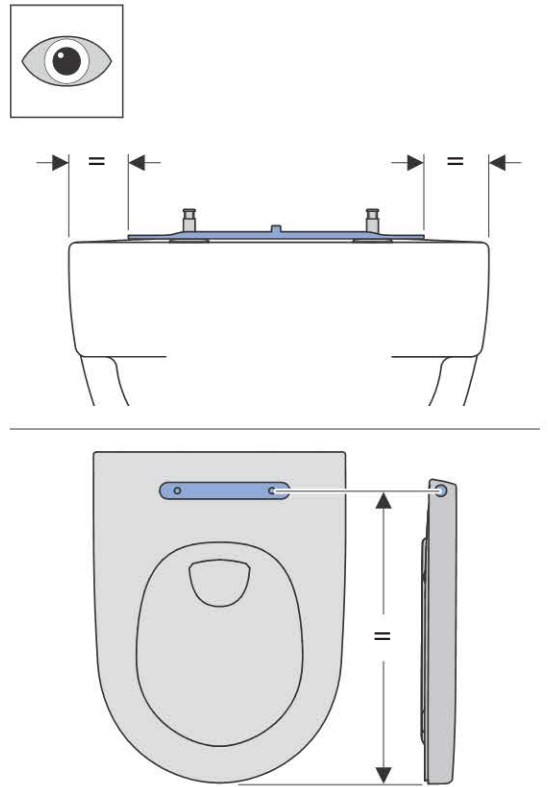

6

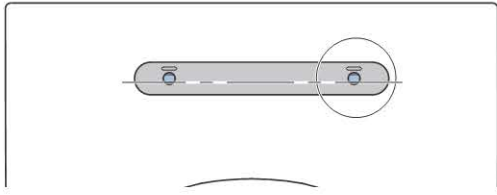
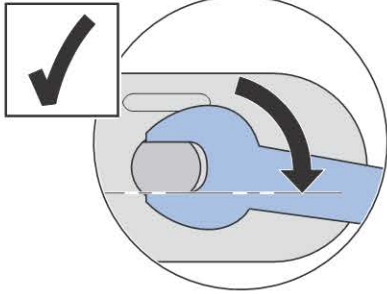
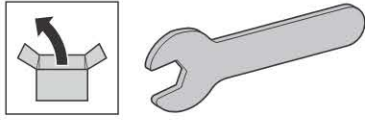

7

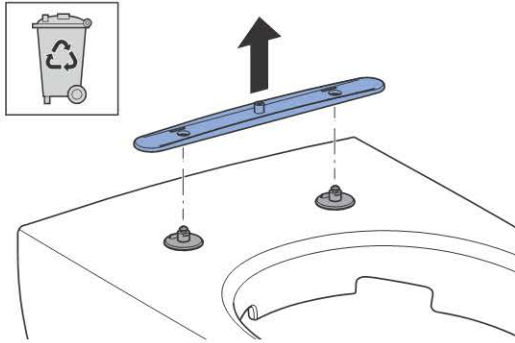

2

1

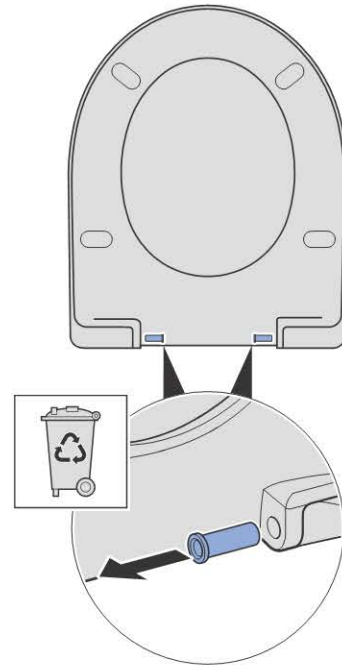

2

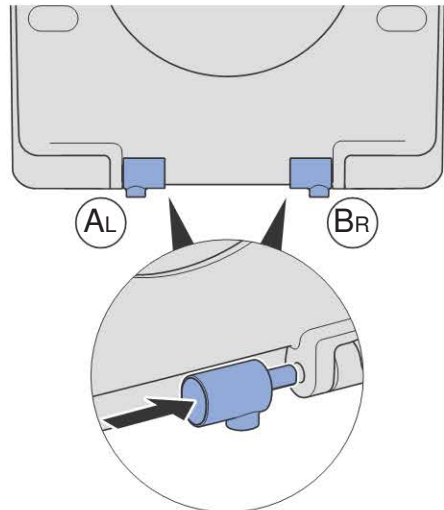

3

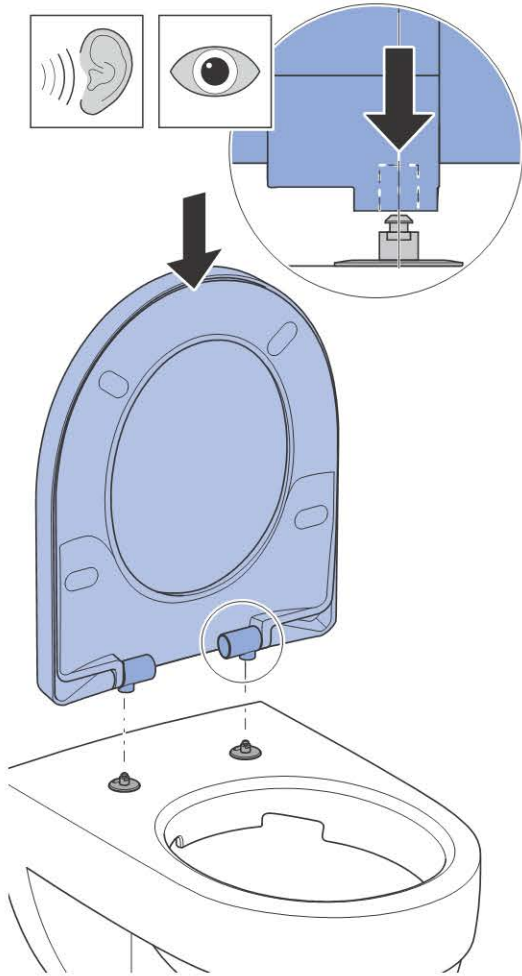

3

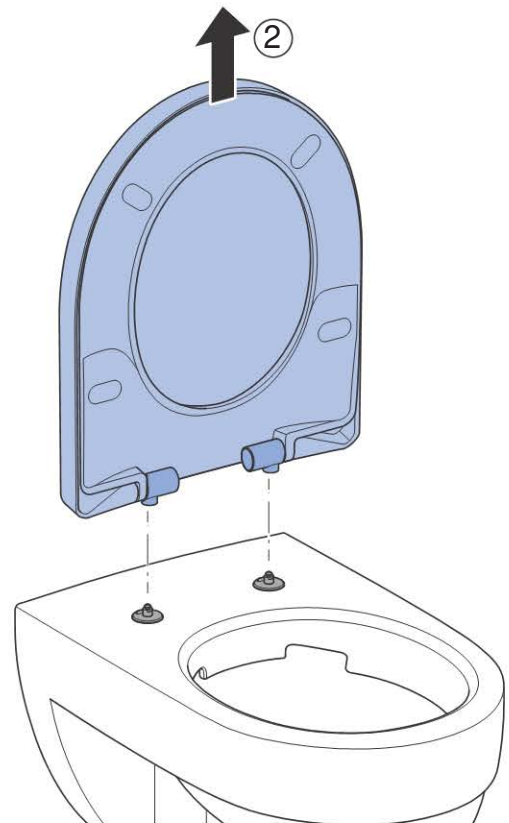
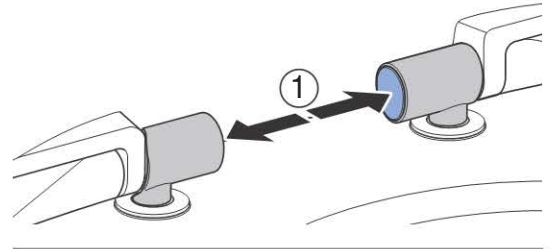

Geberit International AG  
Schachenstrasse 77, CH-8645 Jona  
documentation@geberit.com  
www.geberit.com

