

KTSX047P (700x2000)
KTSX042P (800x2000)
KTSX041P (900x2000)
KTSX043P (1000x2000)
KTSXN47P (700x2000)
KTSXN42P (800x2000)
KTSXN41P (900x2000)
KTSXN43P (1000x2000)
KTS 000X (2000)
KTS N00X (2000)

PL Instrukcja montażu
EN Assembly instructions
DE Montageanleitung
LV Instalēšanas instrukcijas
RU Инструкция по установке
UK Інструкція по установці
RO Instrucțiunile de instalare
HR Upute za montažu

FR Instructions d'installation
NO Installasjonsinstruksjoner
LT Instaliavimo instrukcijas
FI Asennusohjeen
SK Pokyny na inštaláciu
HU Telepítési utasítások
CS Pokyny k instalaci
SV Monteringsanvisning

PL Przed rozpoczęciem montażu należy sprawdzić czy towar nie posiada wad, oraz czy jest kompletny. Firma Deante sp. z o.o. nie ponosi odpowiedzialności za widoczne defekty produktu po jego montażu. Przed montażem szyć należy wyczyścić okolice ich mocowań przy użyciu podstawowych środków czystości przeznaczonych do czyszczenia szkła. Do montażu zaleca się używania tylko i wyłącznie sylikonu sanitarnego. Po rozpakowaniu kabiny chronić szyby przed uderzeniami podczas odkładania ich na podłoże (np. odkładając je na karton). Unikaj uderzeń o krawędzi szyć bądź ich rogi.

EN Before starting the assembly, it is necessary to check whether or not a cubicle has defects and is complete. The company: Deante sp. z o.o. does not bear responsibility for noticeable defects of the product after its assembly. Before installation of panes, it is required to clean out places of their fixing with the use of basic cleaners intended for cleaning glass. For assembly it is advisable to use only sanitary silicone. After unpacking the cubicle, protect panes from hits while putting them on the surface (e.g. by putting them on a cardboard). Avoid hits on panes' edges or their corners.

DE Vor der Montage soll überprüft werden, ob die Ware mangelfrei und vollständig ist. Die Firma Deante sp. z o.o. haftet nicht für sichtbare Produktdefekte nach seiner Montage. Vor der Glasscheibenmontage sind die Stellen um die Befestigungen herum mit normalem Glasreiniger sauber zu machen. Es wird empfohlen, für die Montage nur Sanitär-Silikon zu verwenden. Nach der Auspackung der Kabine sollen die Glasscheiben vor Schlägen infolge des Ablegens auf den Boden (z.B. wenn die auf den Karton abgelegt werden) geschützt werden. Man soll vermeiden, gegen die Scheibenkanten bzw. -ecken zu schlagen.

LT Pirms sākt uzstādīšanu, pārbaudiet, vai precei nav defektu, un, vai tā ir nokomplektēta. Uzņēmums Deante sp. z o.o. neatbild par redzamiem produkta defektiem pēc montāžas. Pirms caurspīdīgo sienīņu uzstādīšanas, tās jānotīra ar stiprinājuma vietām, izmantojot mazgāšanas līdzekļus, kas paredzēti stikla tīrīšanai. Uzstādīšanai ieteicams izmantot tikai un vienīgi sanitāro silikonu. Pēc kabīnes detaļu izsaiņošanas sargāt caurspīdīgās sienīņas pret triecienu no novietošanas laikā uz pamatnes (piem. novietojiet tās uz kartona kastes). Izvairīties no caurspīdīgo sienīņu malu vai stūru sasiņāšanas.

RU Перед началом монтажа следует убедиться в наличии всех элементов и в отсутствии дефектов. Фирма Deante sp. z o.o. не несет ответственности за видимые дефекты изделия после его монтажа. Перед началом монтажа стекол следует очистить область их установки, при использовании основных моющих средств, предназначенных для чистки стекла. Для монтажа рекомендуется использовать только санитарный силикон. После распаковки кабины следует защитить стекла от ударов при откладывании их на пол (например, класть их на картон). Избегайте ударов о края стекол или об их углы.

UA Перед початком збірки і установки перевірити чи товар не має дефектів і чи повністю укомплектований Фирма Deante sp. z o.o. (Данте Антчак Повне товариство) не несе від -повідальність за дефекти виробу, які проявилися після його монтажу. Перед монтажем скляних стінок необхідно вичистити зони їх кріплення за допомогою миючих засобів, призначених для миття скла. Для монтажу рекомендується використовувати тільки і виключно санітарний силікон. Після розпакування кабінні оберігайте скляні елементи від ударів під час відкладання (напр. відкладення їх на картон). Уникайте ударів крайні скла або їх кутами.

RO Înainte de începerea montajului trebuie verificat dacă marfa nu posedă defecte și dacă este completă. Firma Deante sp. z o.o. nu este responsabilă pentru defecte vizibile ale produsului după montajul acestuia. Înainte de montajul geamurilor trebuie curățate locurile de montare cu folosirea produselor de curățenie de bază, destinate curățării sticlei. Pentru montaj se

recomandă folosirea exclusivă a siliconului sanitar. După despachetarea cabinei, protejați geamurile împotriva impactului în timpul așezării lor pe podea (plasându-le de exemplu pe carton). Evita loviri la marginile sau colțurile acestora.

HR Prije početka montaže provjeriti da li je proizvod kompletn i da li nema ikakvih nedostataka. Tvrtka Deante sp. z o.o. ne snosi odgovornost za vidljive nedostatke na proizvodu nakon montaže istog. Prije montaže stakala potrebno je pažljivo očistiti mjesta na kojima će stakla biti montirana, pomoću uobičajenih sredstava za čišćenje stakla. Za izvođenje montaže preporučuje se isključivo sanitarni silikon. Nakon raspakiranja kabine potrebno je zaštititi stakla od oštećenje pri priklopu stavljanja ih na pod – treba prethodno zaštititi pod kartonom. Treba izbjegavati udaranja u ivice ili uglove stakala.

FR Avant de commencer l'installation vérifiez si la marchandise est sans défauts et si elle est complète. La société Firma Deante sp. z o.o. se décline de toute responsabilité des défauts visibles apparus après l'installation. Avant l'installation nettoyez les surfaces de fixation avec des produits de nettoyage pour le verre. Pour l'installation utilisez uniquement le silicone sanitaire. Après le déballage de la cabine protégez les vitrages contre le choc lorsqu'elle est posée sur le sol (posez les vitrages sur un carton). Evitez les chocs pouvant affecter les vitrages ou leurs bords.

NO Før oppstart av monterig, sjekk om varen ikke har feil og om settet er komplett. Selskapet Deante sp. z o.o. tar ikke ansvar for synlige produktfeil etter at produktet er montert. Før monterig av glass skal festepunkter rengjøres ved hjelp av vanlige vaskemidler til rengjøring av glass. Til monterig bør kun sanitær silikon brukes. Etter utpakking av kabinettet, beskytt glasset mot slag, mens du legger det på gulvet (legg glass på kartong). Unngå slag på glasskantene eller glasshjørnet.

LV Prieš pradēdant motuoti kabina, pirmiausia reikia patikrinti ar prekė neturi trūkumų, ir ar yra pilnai sukomplektuota. Firma Deante sp. z o.o. neprisiima atsakomybės už akivaizdžius gaminių defektus tu po montažo. Prieš atliekant montavimo darbus būtina išvalyti tvirtinamąsias vietas naudojant valymo priemones skirtas stiklams valyti. Montavimui rekomenduojama naudoti veini tiktai sanitarinį silikoną. Išėmus kabina iš pakuoėes būtina saugoti kabinos stiklus nuo sutrenkimų yaė dedant juos ant grindinio (pav. patiesiant po jais kartono lakėtus). Būtina stengtis išvengti stiklų kraėtų ar kampų sutrenkimo.

FI Ennen asennuksen aloittamista tulee tarkistaa, onko tavaraa vikoja sekä onko tavara täydellinen. Deante sp. z o.o. ei ole vastuussa tuotteesta olevista näkyvistä vioista sen asennuksen jälkeen. Ennen suihkukaapin lasien asennusta niiden tulee kiinnityskohtien alueet puhdistaa käyttäen lasin puhdistukseen tarkoitettuja peruspuhdistusaineita. Asennuksen suositellaan käytettäväksi vain ja ainoastaan saniteettisilikonina. Suihkukaapin pakkauksesta purkamisen jälkeen lasit tulee suojata iskua vastaan niiden alustalle asentamisen aikana (esim. suojaamalla ne pähällä). Vältä iskuja levyjen reunoihin tai kulmiin.

SK Pred montážou skontrolujte, či tovar nie poškodený, a či je kompletný. Firma Deante sp. z o.o. nenesie žiadnu zodpovednosť za vady viditeľné na produkte po jeho namontovaní. Skla v blízkosti miesty ich upevnenia pred montážou vyčistite pomocou základných čistiacich prostriedkov určených na čistenie skla. Na montáž používajte výlučne sanitárny silikón. Po rozbalení kabíny chráňte sklá pred nárazmi, ku ktorým môže dochádzať pri ich odkladaní (napr. pri ich odkladaní na kartóne). Vyhnite sa nárazom do hrán alebo rohov skiel.

HU Összeszerelés előtt ellenőrizze, hogy az áru minden eleméről sérülésmentes legyen és megtalálható a csomagolásban. A Deante sp. z o.o. nem vállalja a felelősséget az összeszerelés után észlelt sérülésekért. Az első szerelés előtt tisztítsa meg az összezerősítés helyeit normál üveg tisztító szerrel. A szerelésnél csak és kizárólag szaniter szilikon használjon. Miután kicsoma-

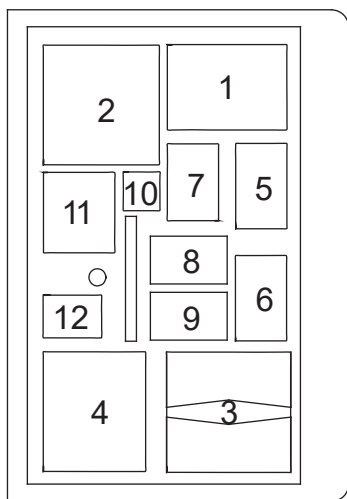
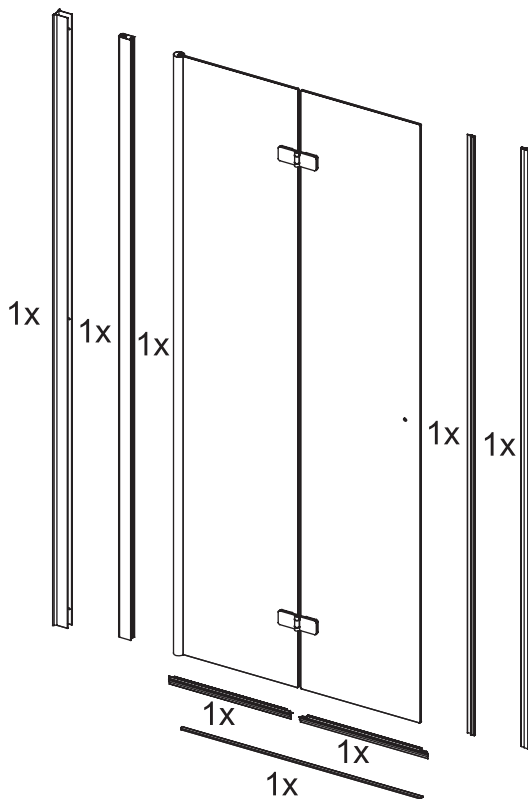

1	x1		6	x4	
2	x1		7	x2	
2	x1		8	x3	
3	x1		9	x3	
3	x1		11	x2	
3	x1		12	x3	
4	x1			x1	
5	x4			x1	



X2

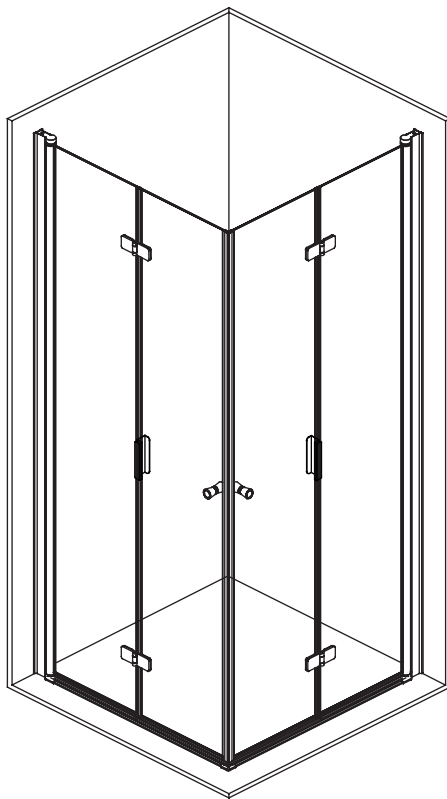

P7-P19

A	x1	
B	x1	
G	x4	 ST4X30
J	x4	
K	x4	

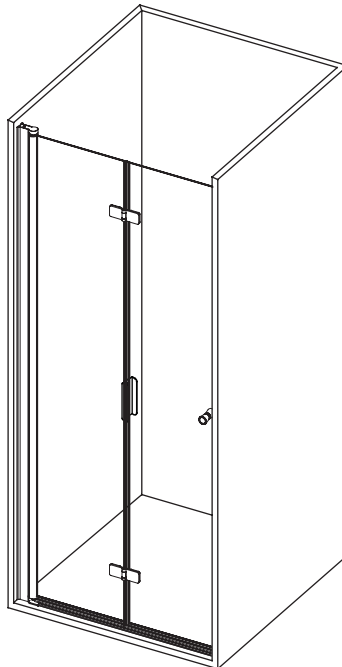
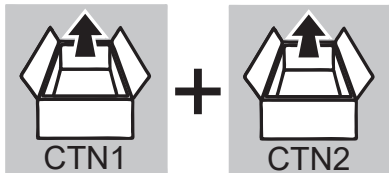
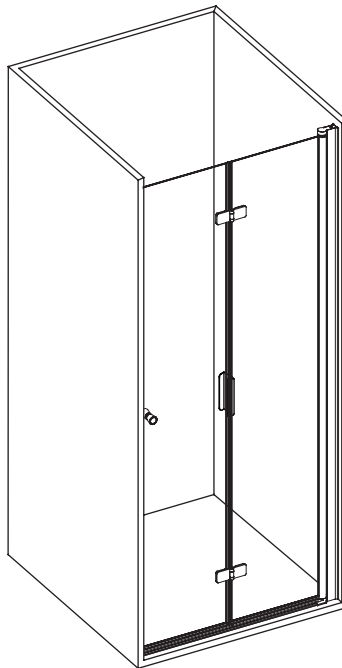
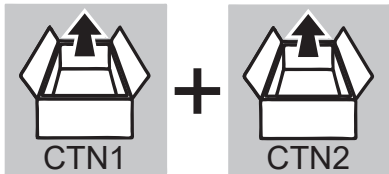

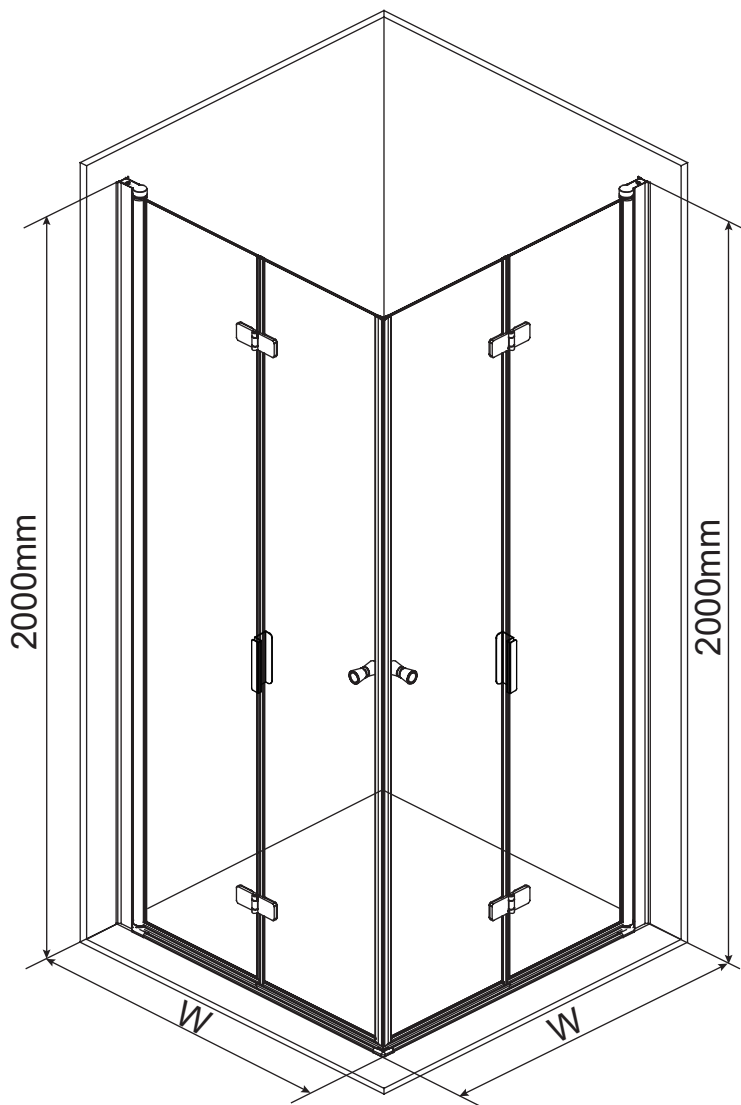

W:

800: 785 mm - 800 mm

900: 885 mm - 900 mm

1000: 985 mm - 1000 mm



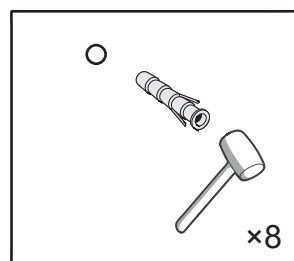
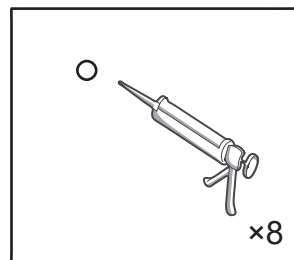
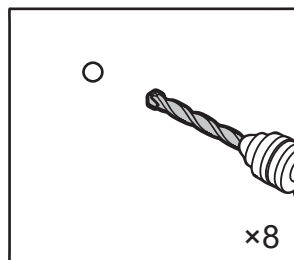
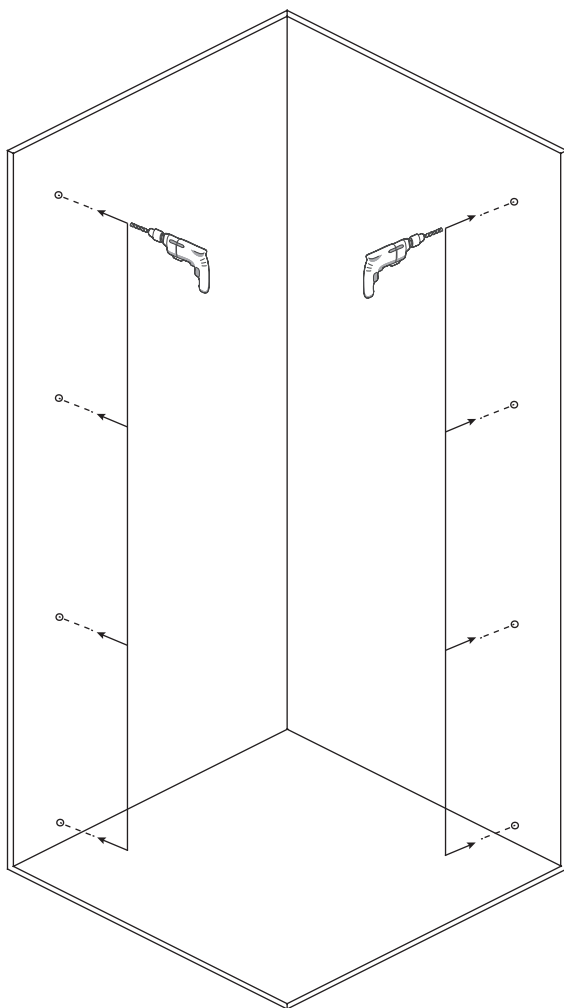

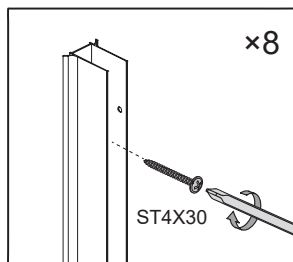
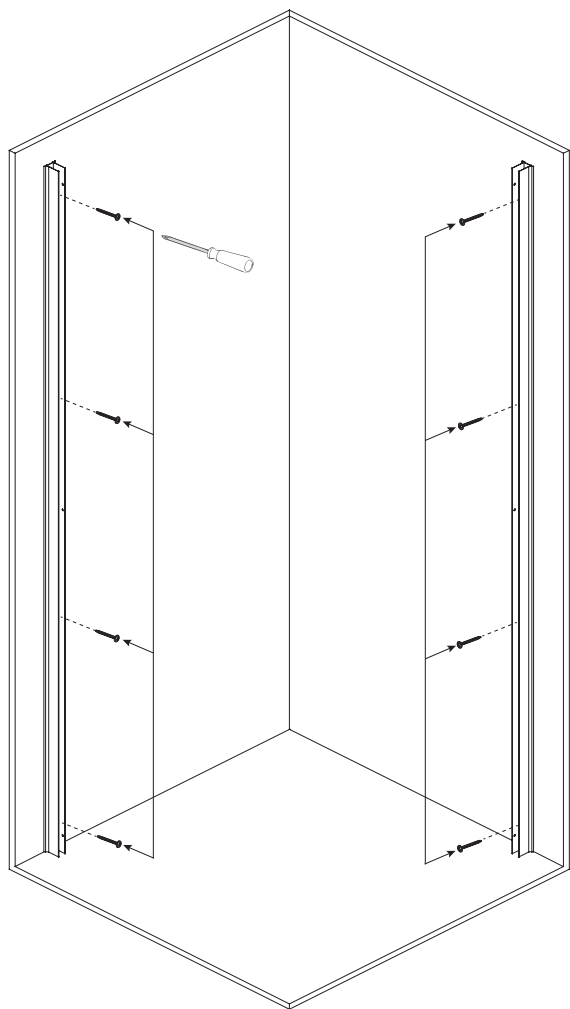

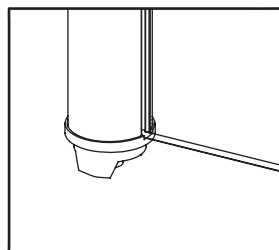
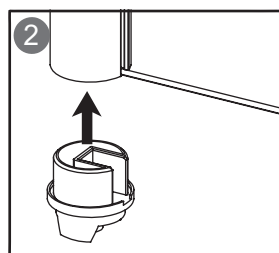
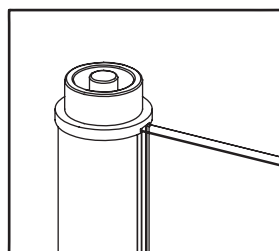
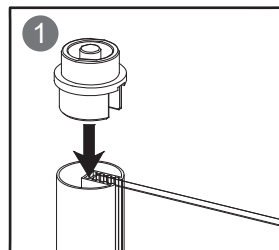
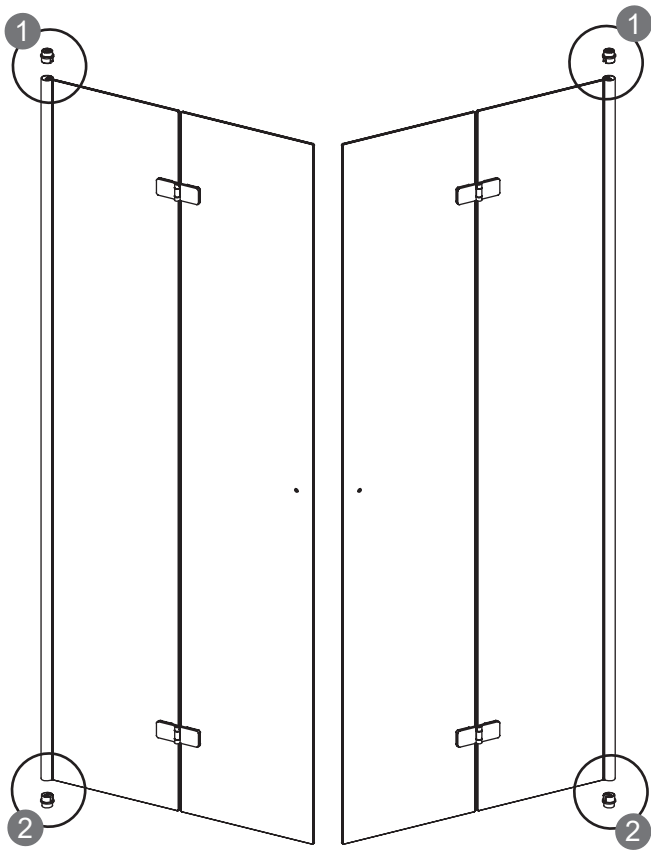

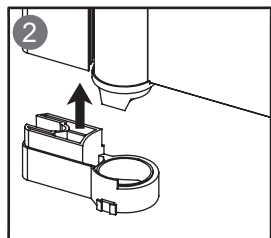
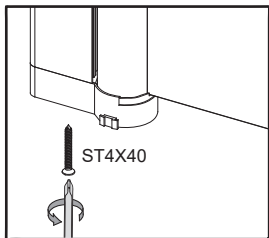
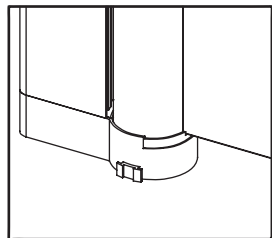
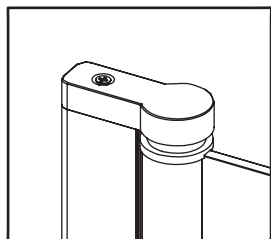
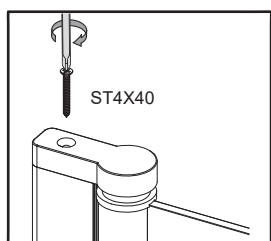
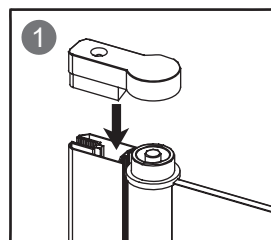
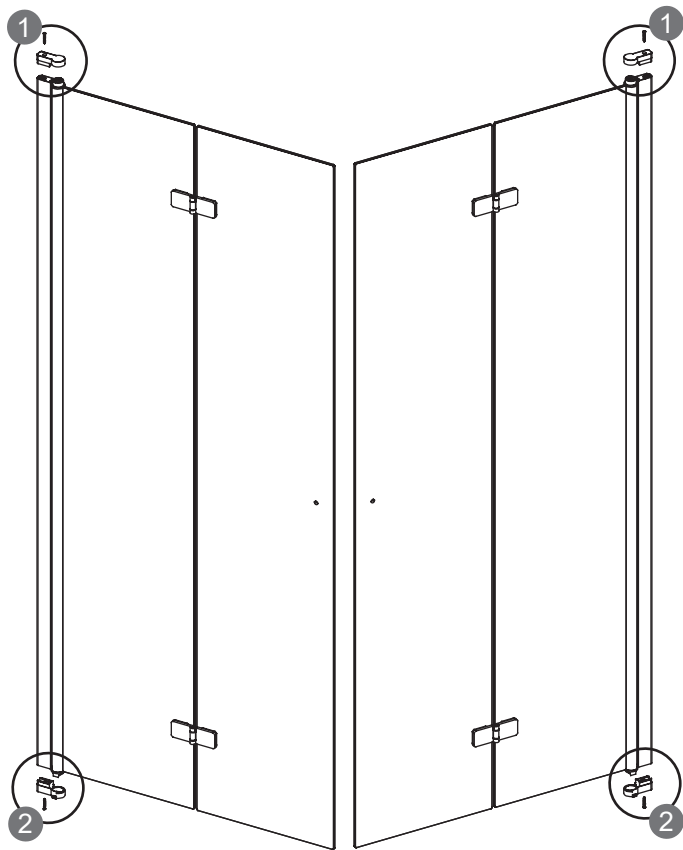

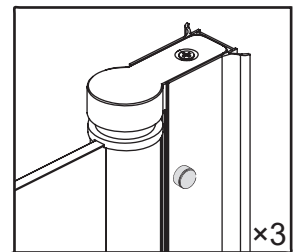
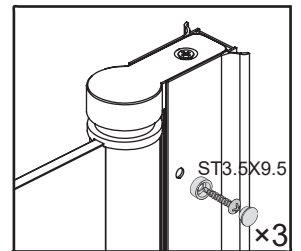
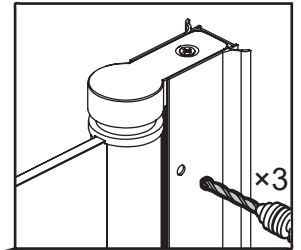
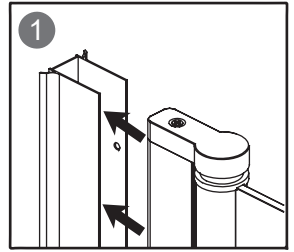
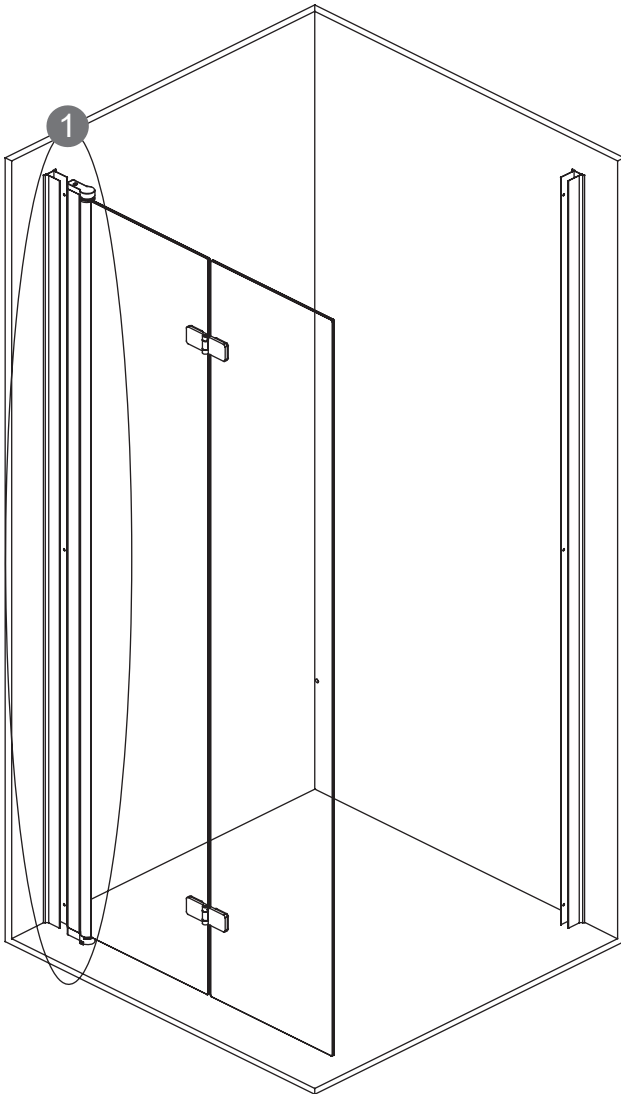

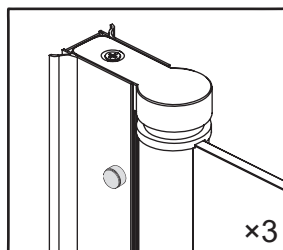
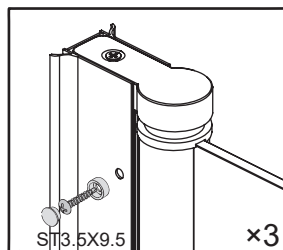
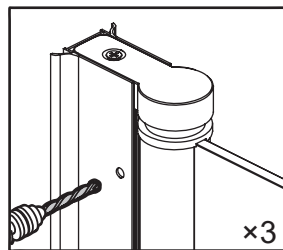
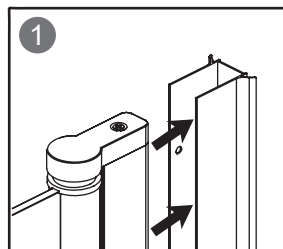
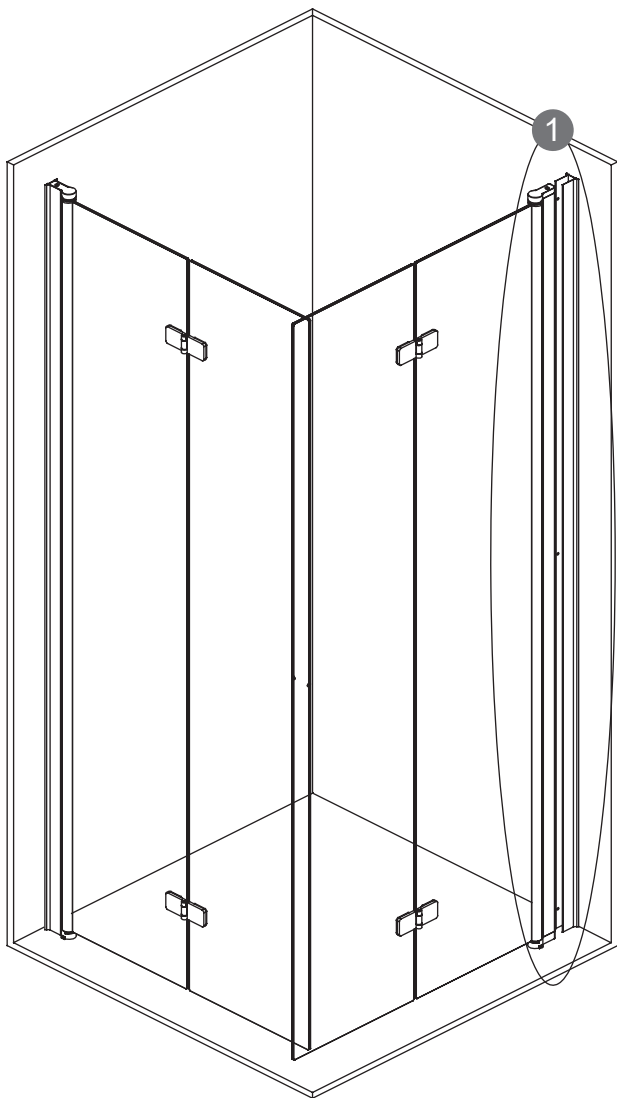

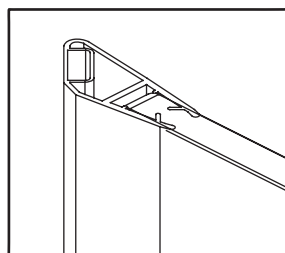
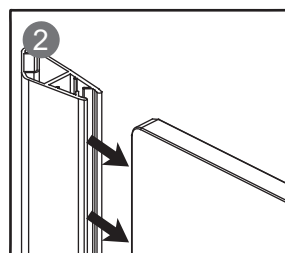
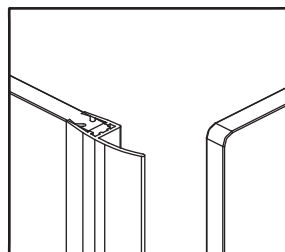
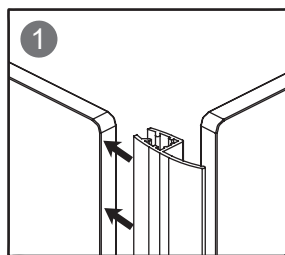
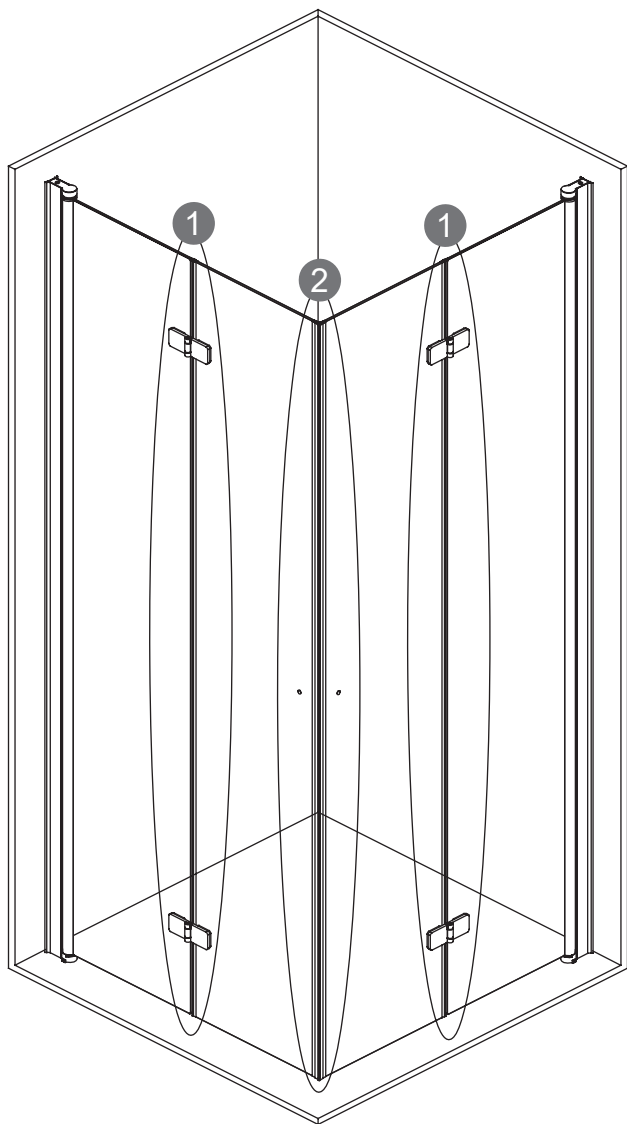

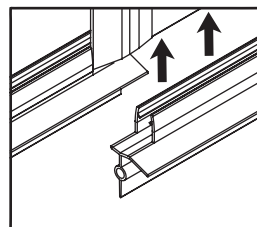
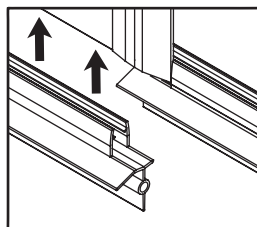
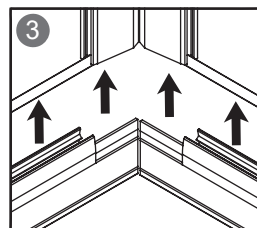
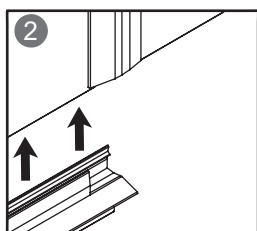
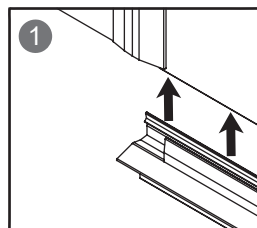
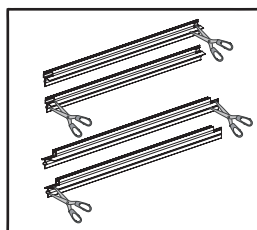
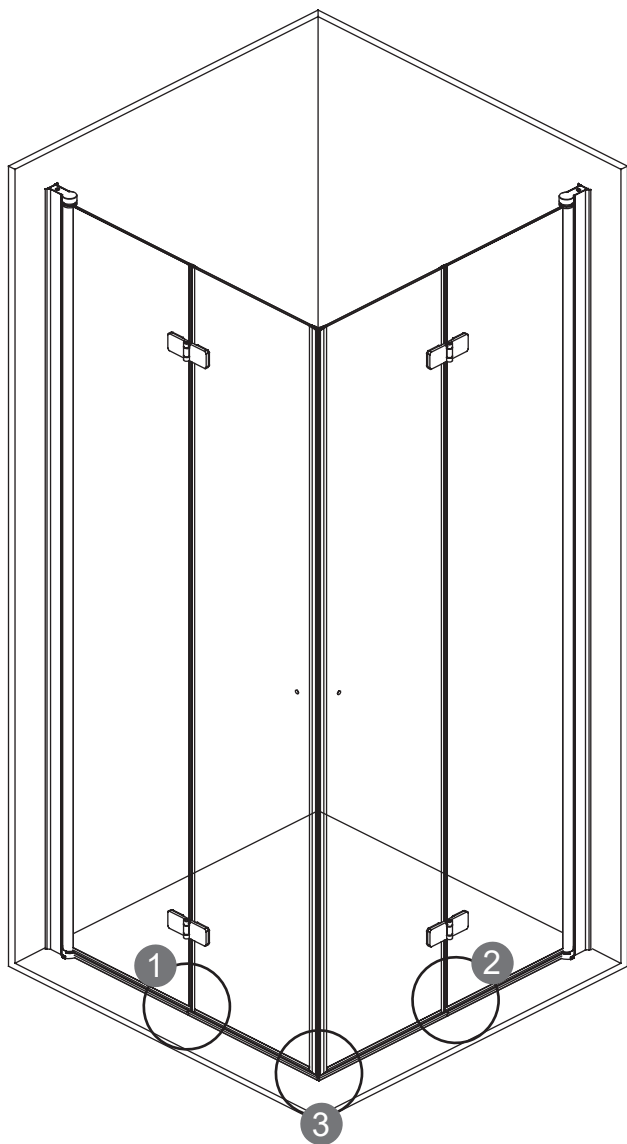

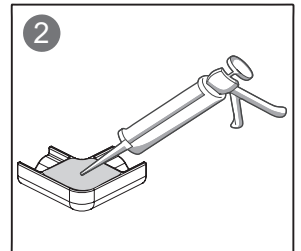
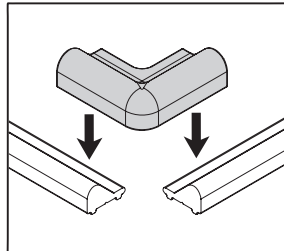
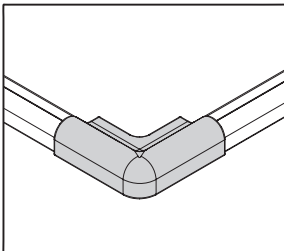
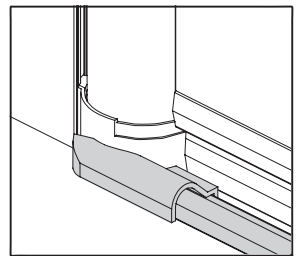
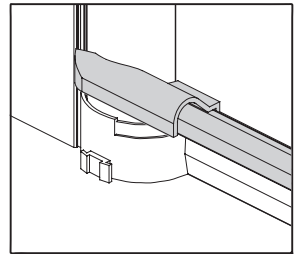
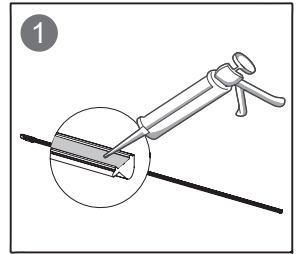
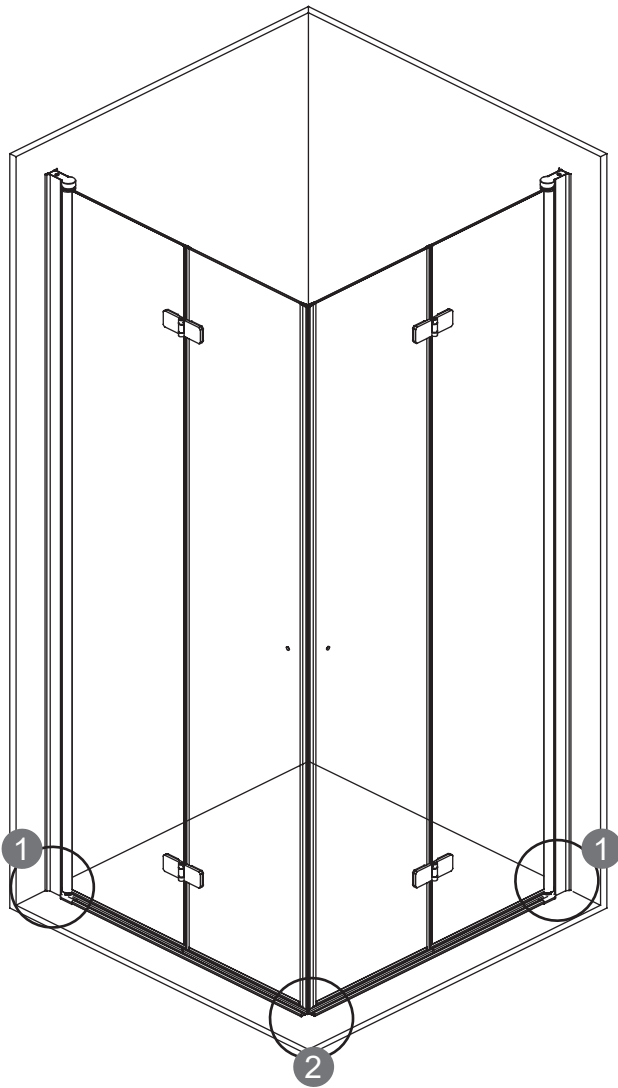

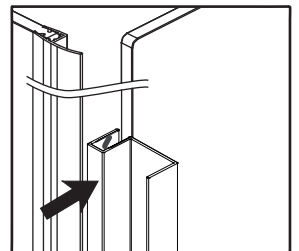
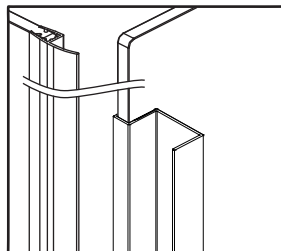
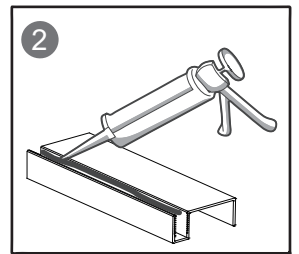
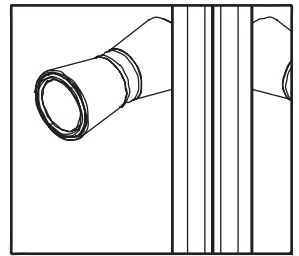
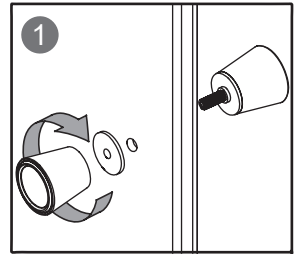
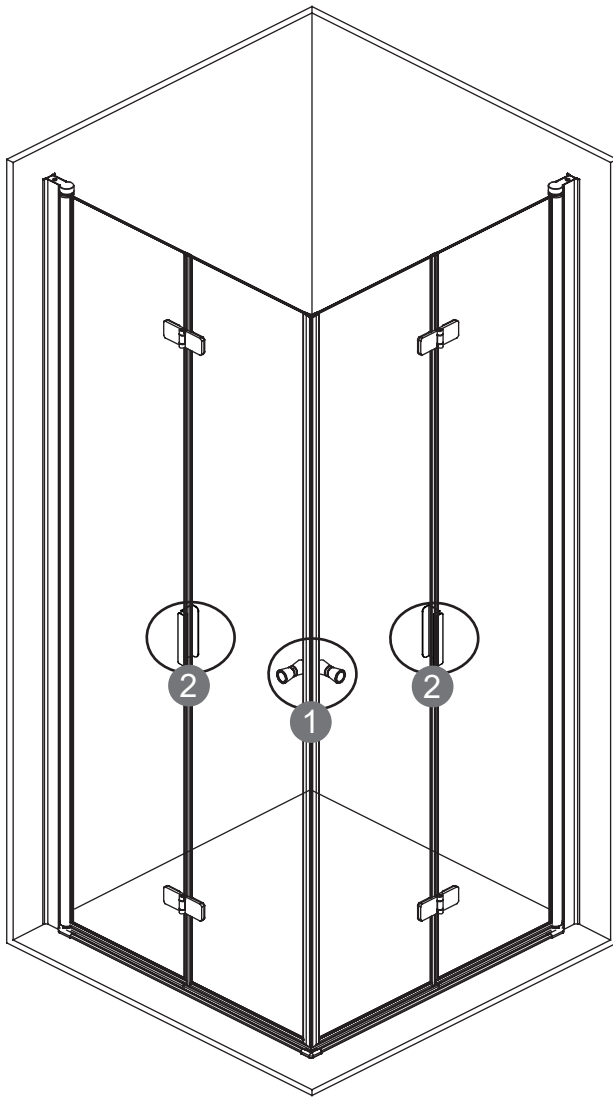

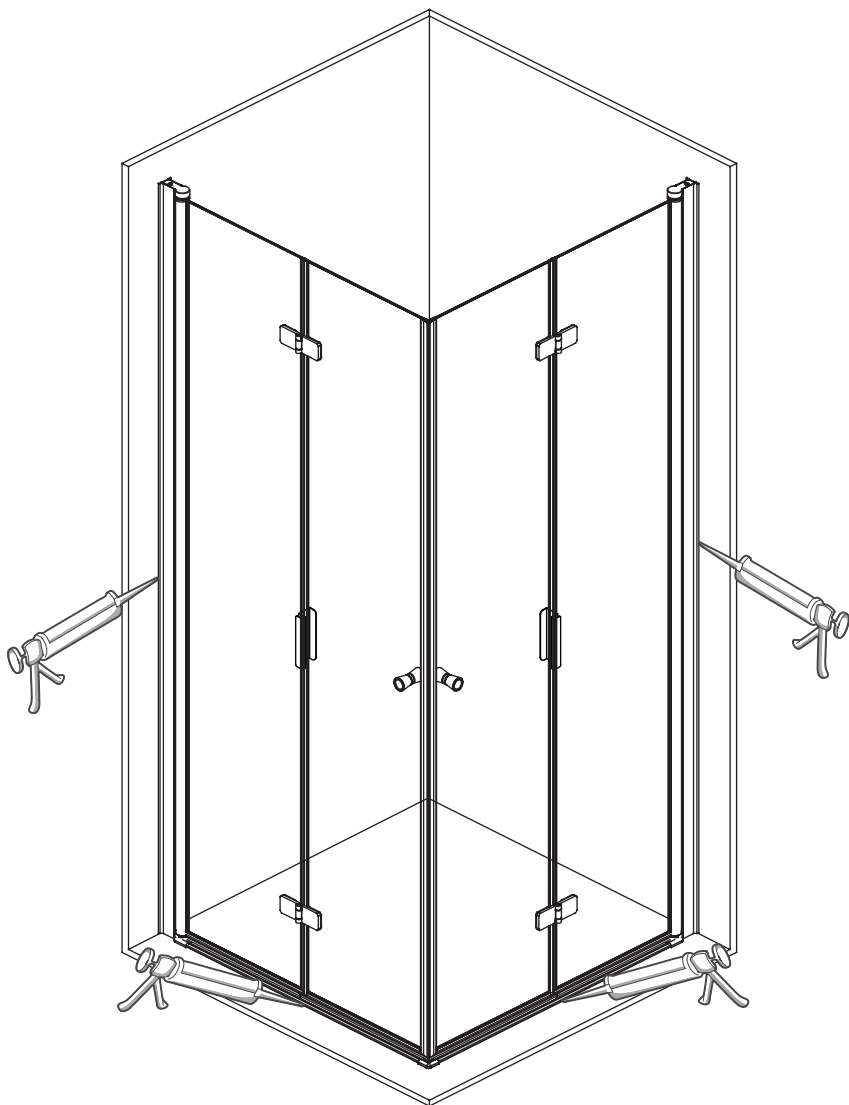

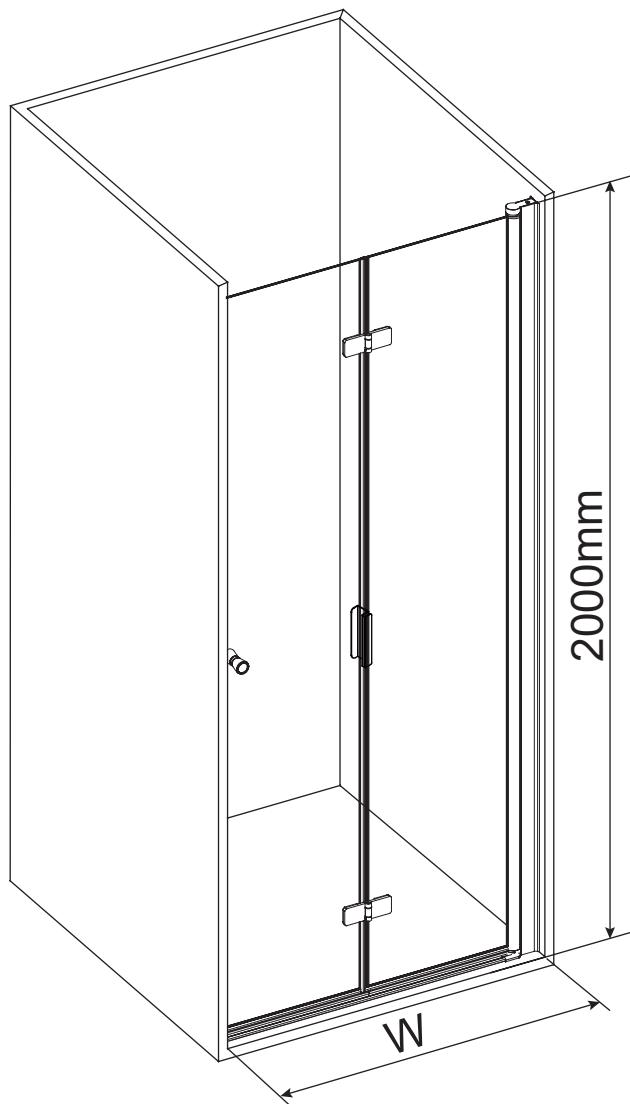

W:

800: 775 mm - 790 mm

900: 875 mm - 890 mm

1000: 975 mm - 990 mm

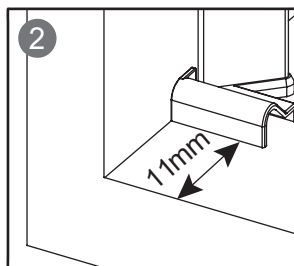
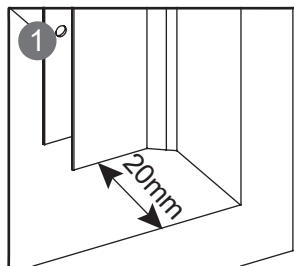
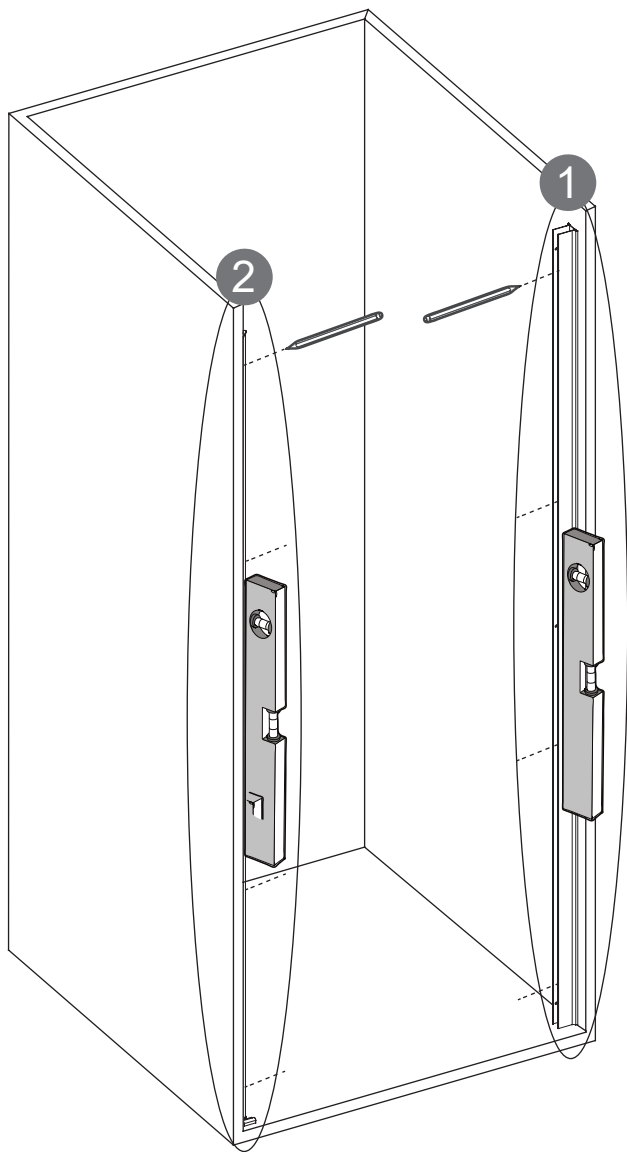

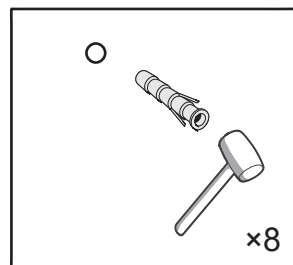
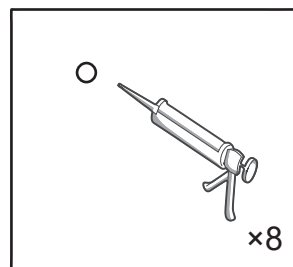
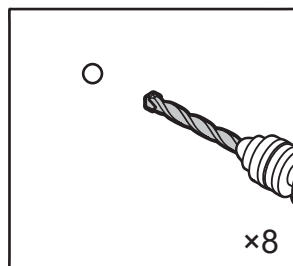
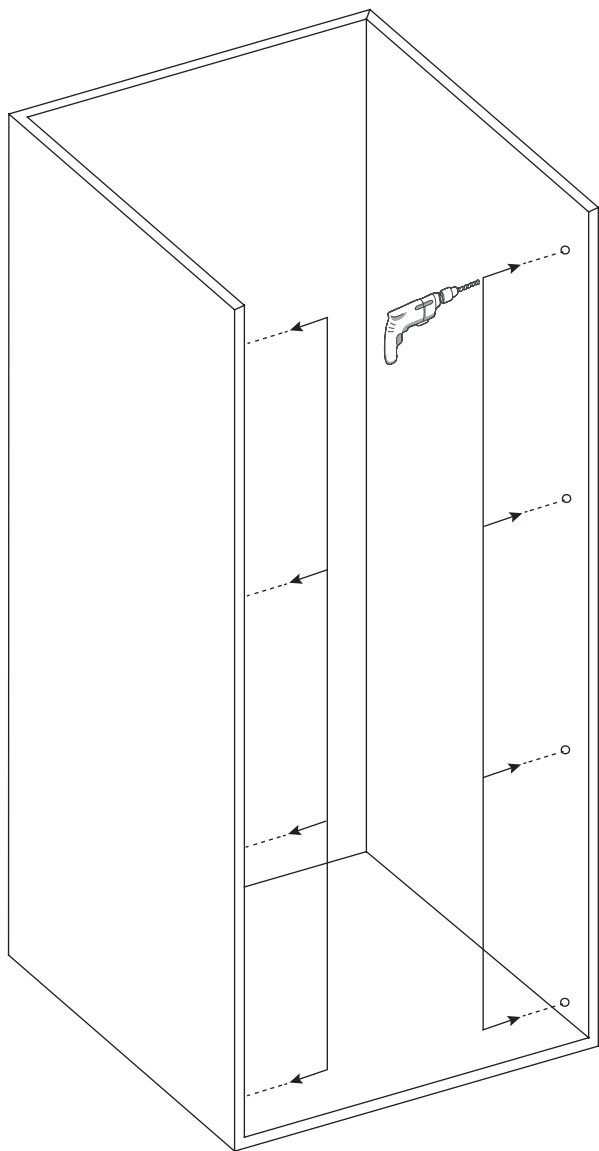

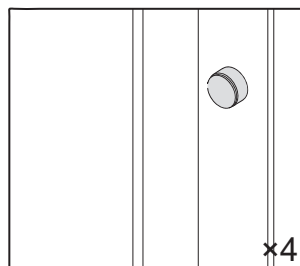
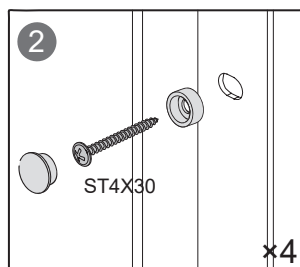
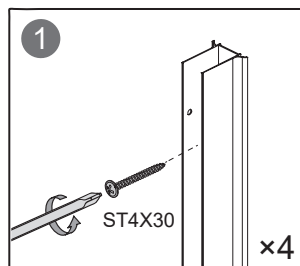
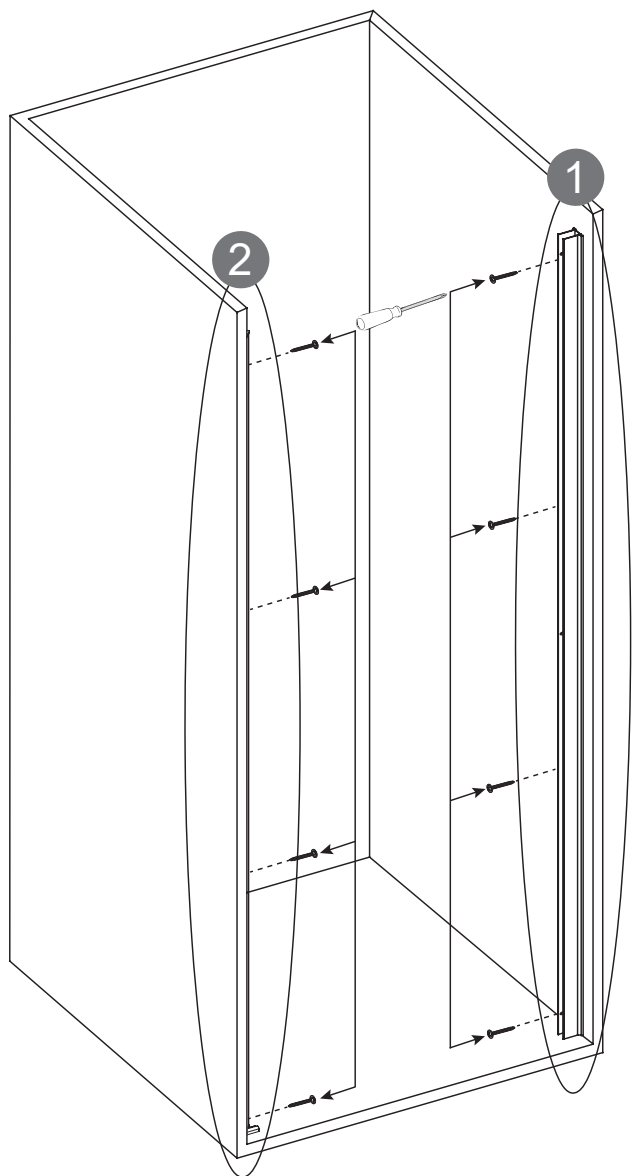

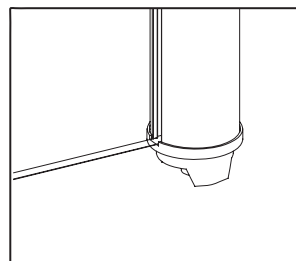
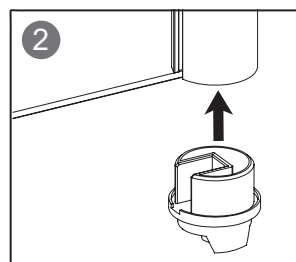
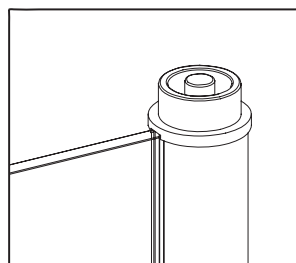
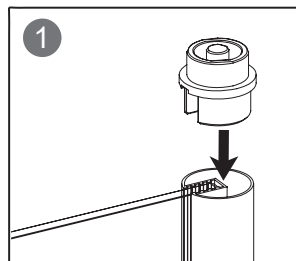
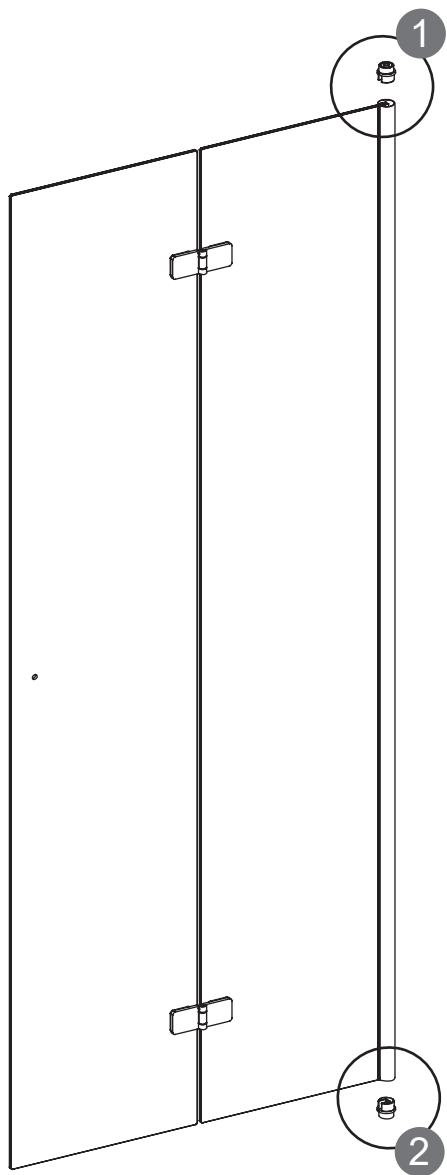

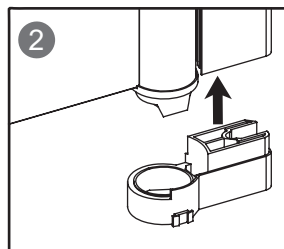
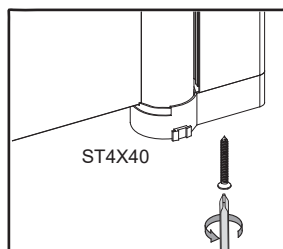
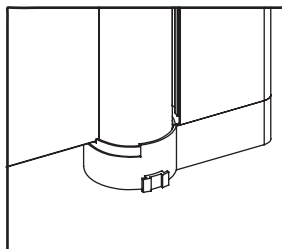
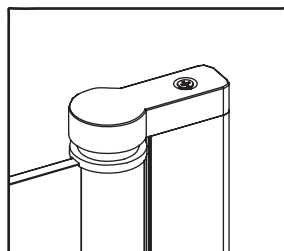
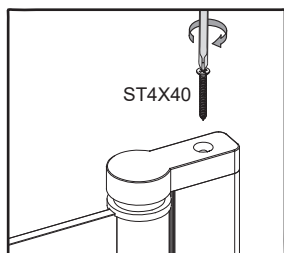
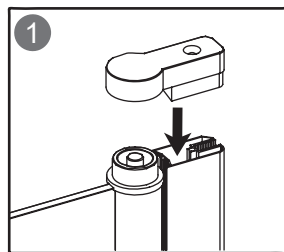
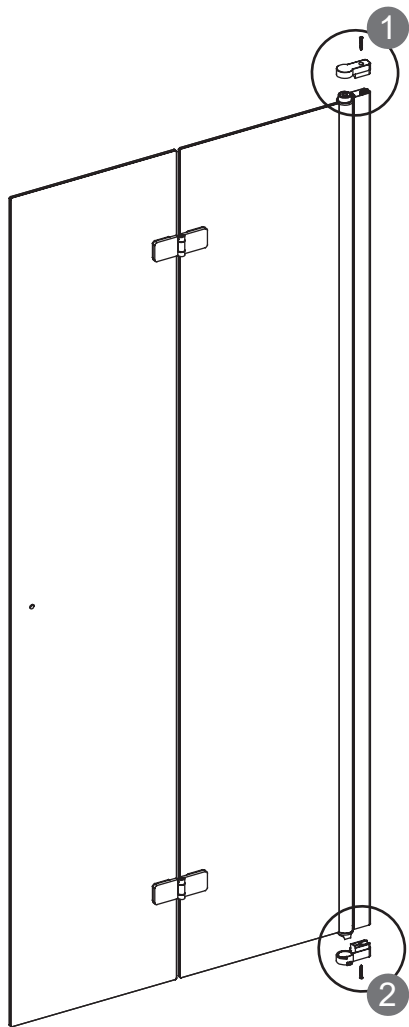

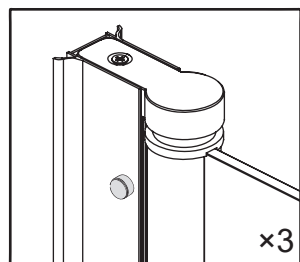
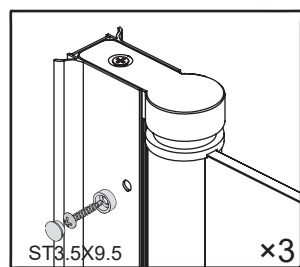
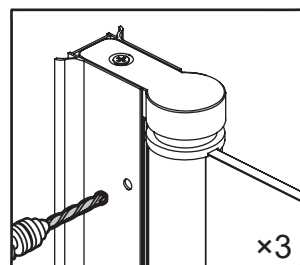
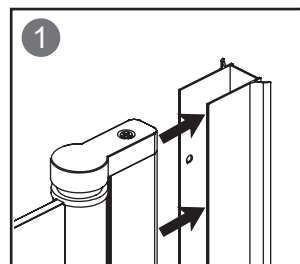
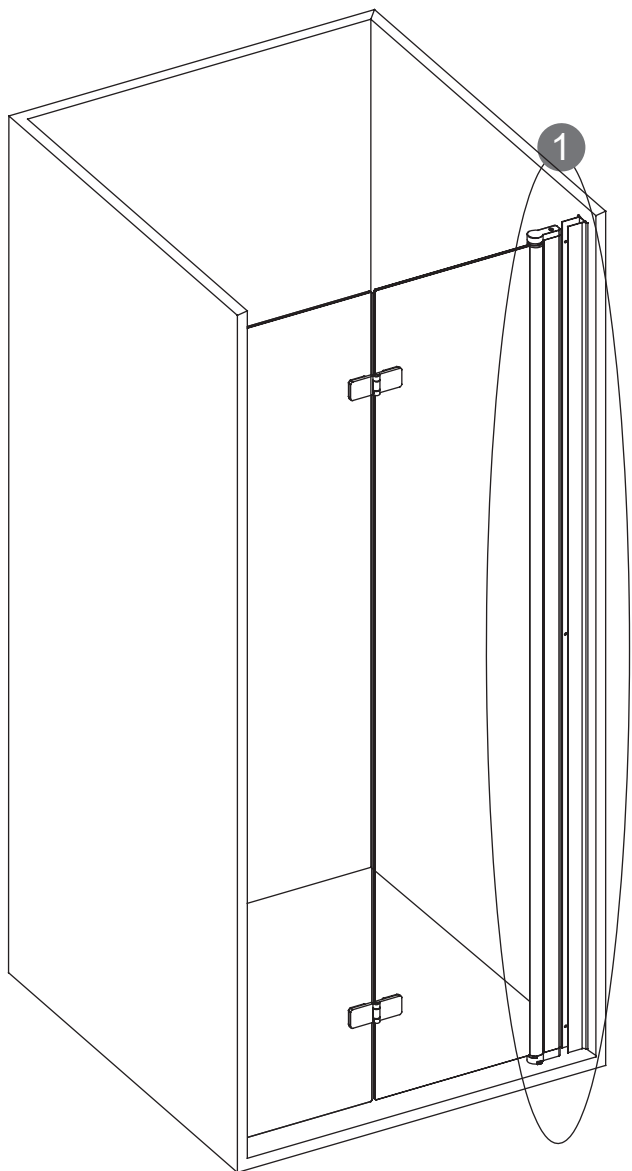

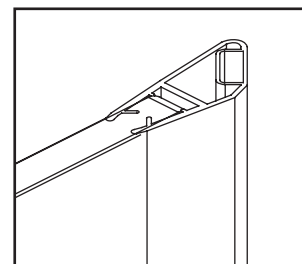
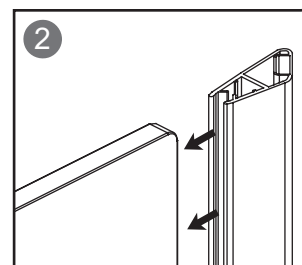
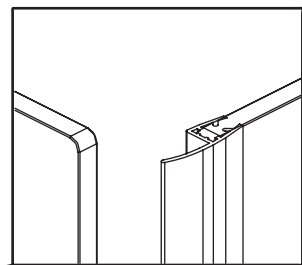
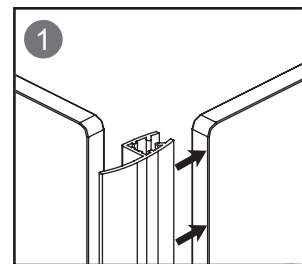
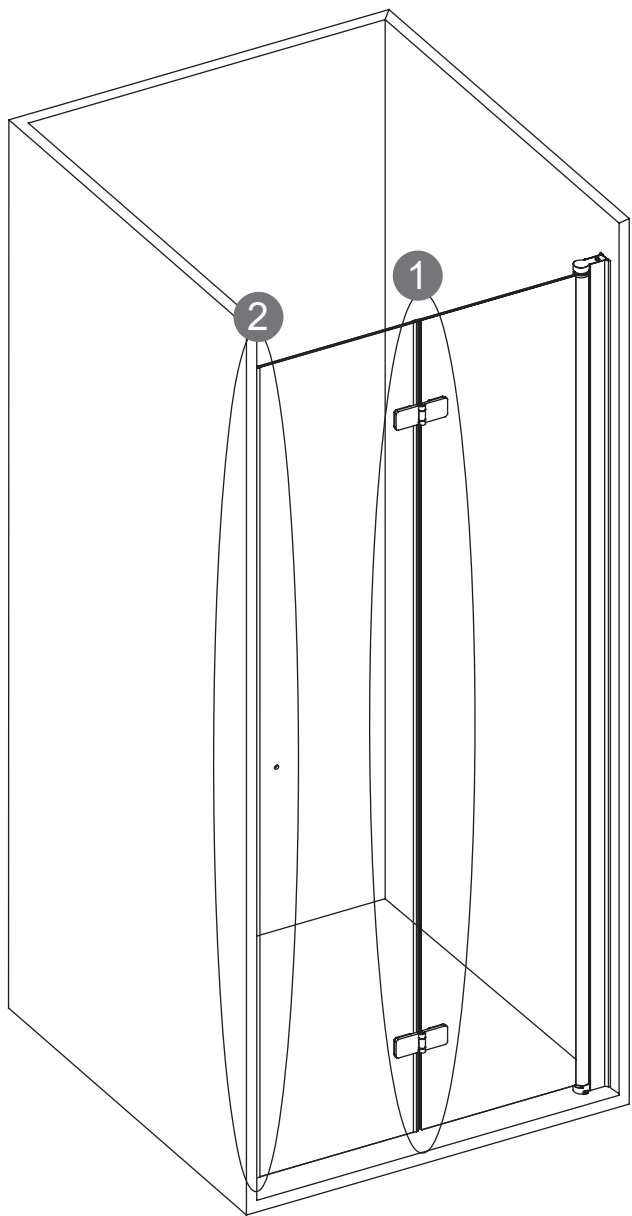

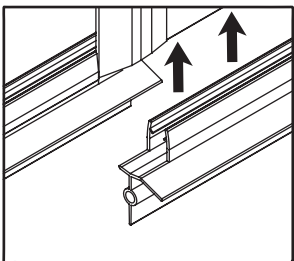
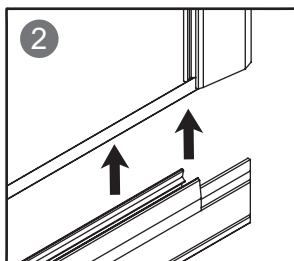
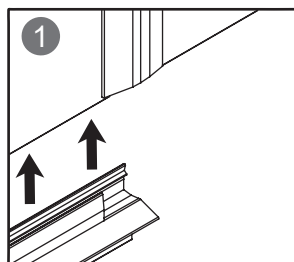
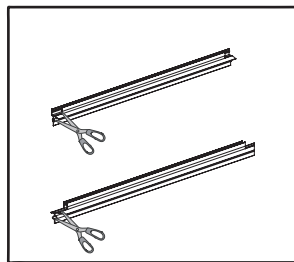
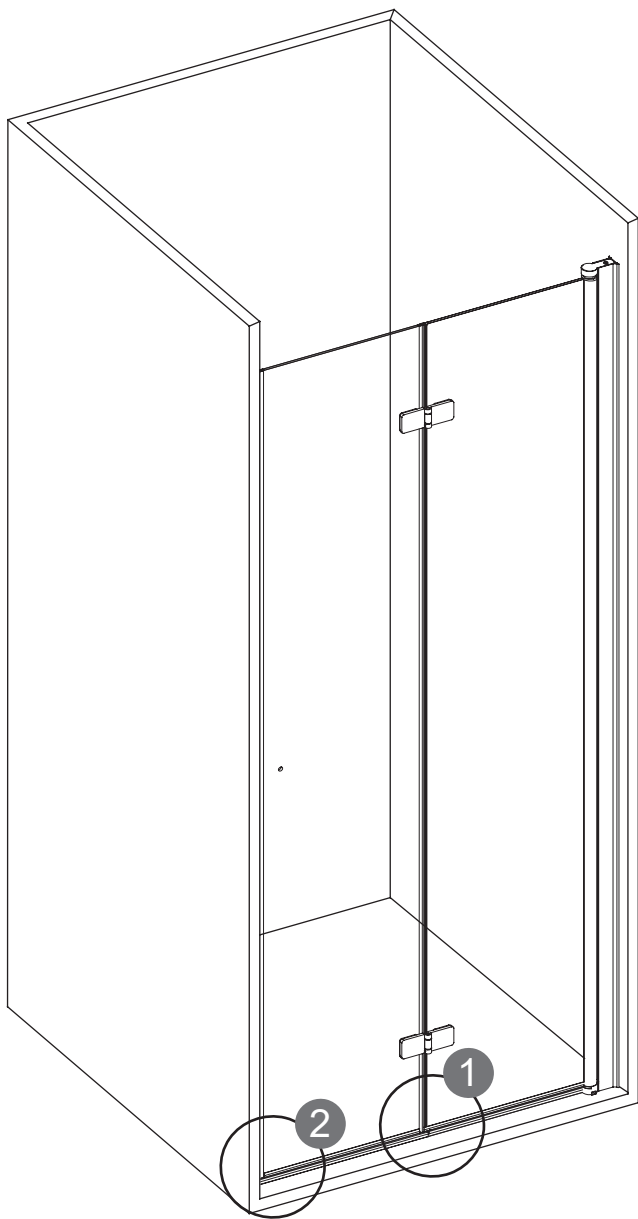

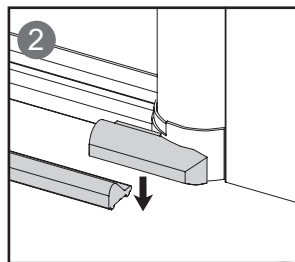
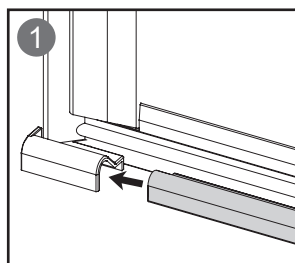
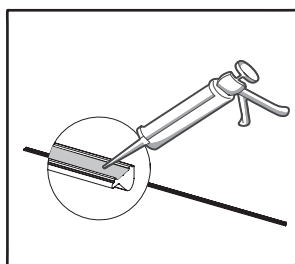
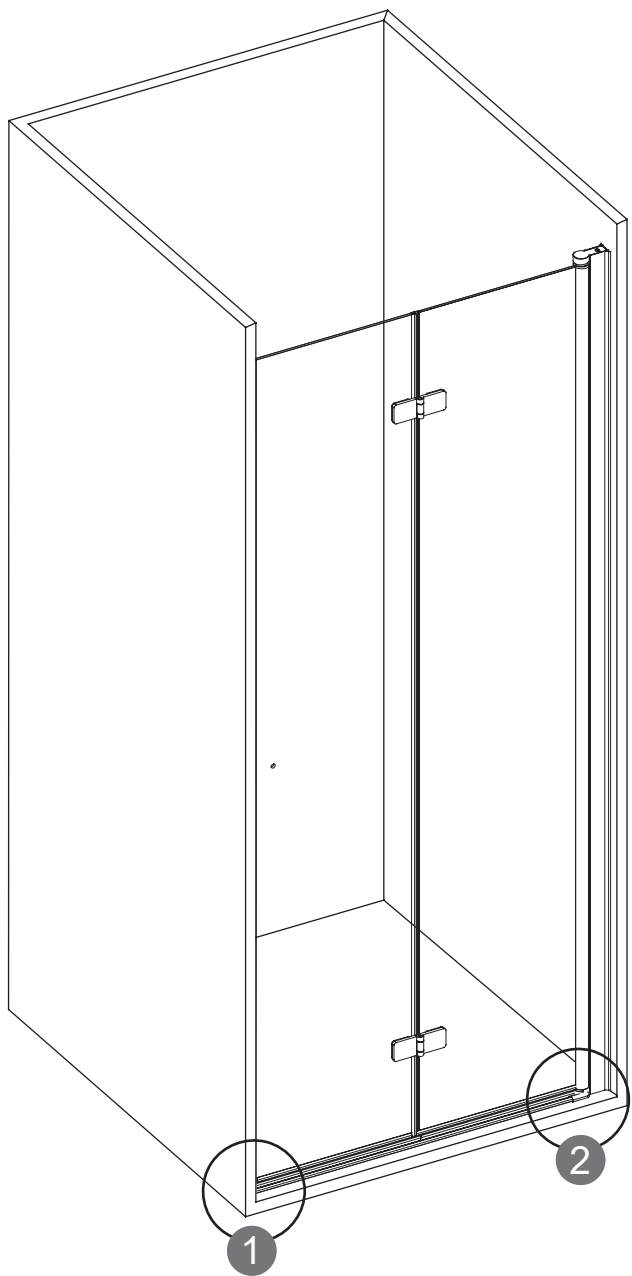

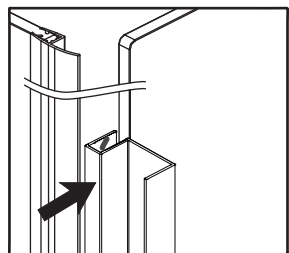
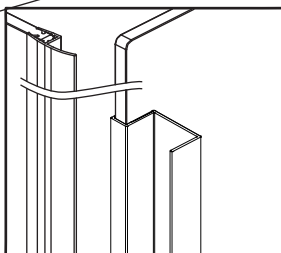
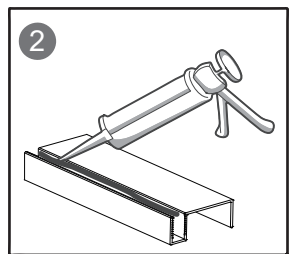
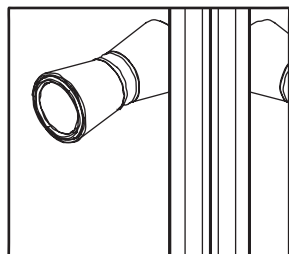
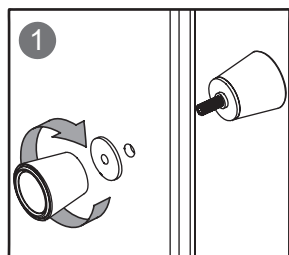
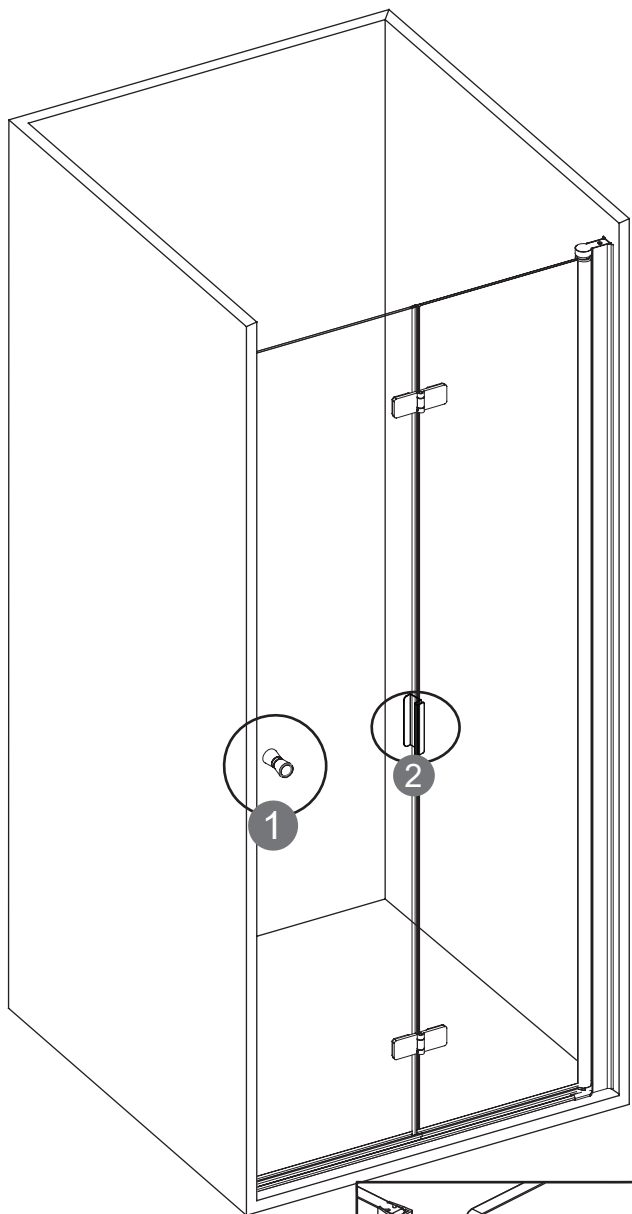

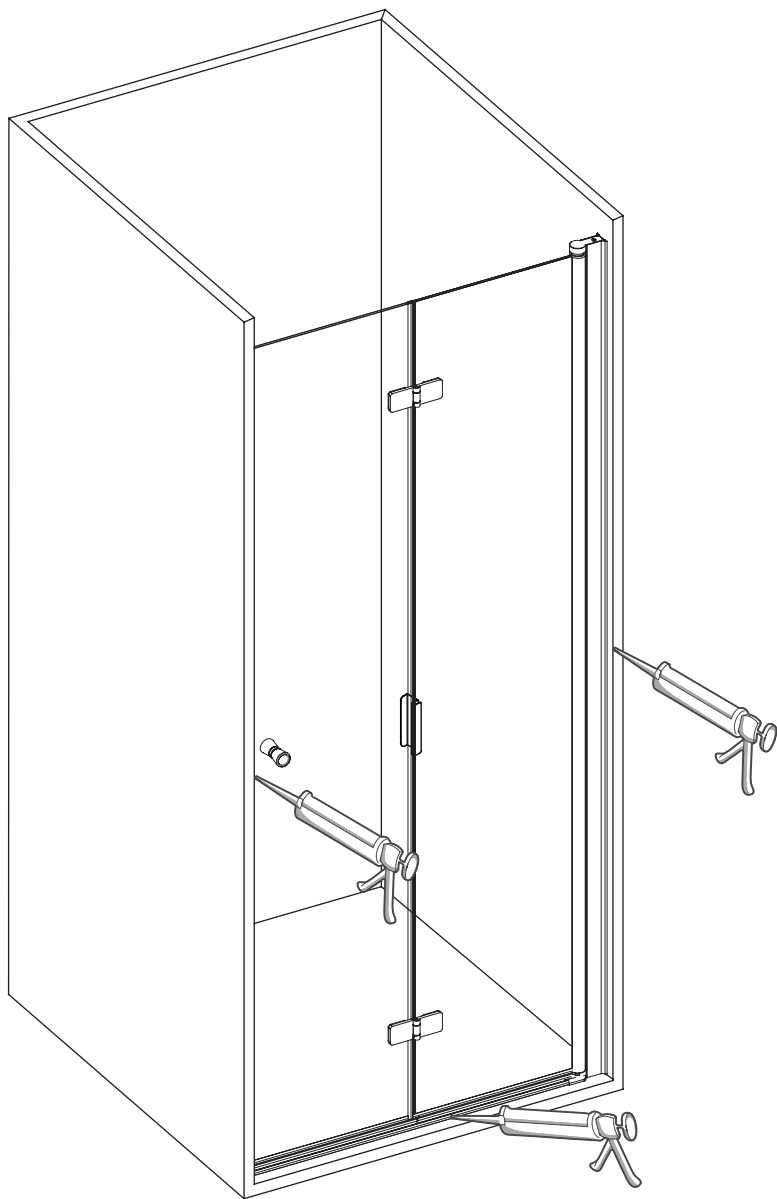

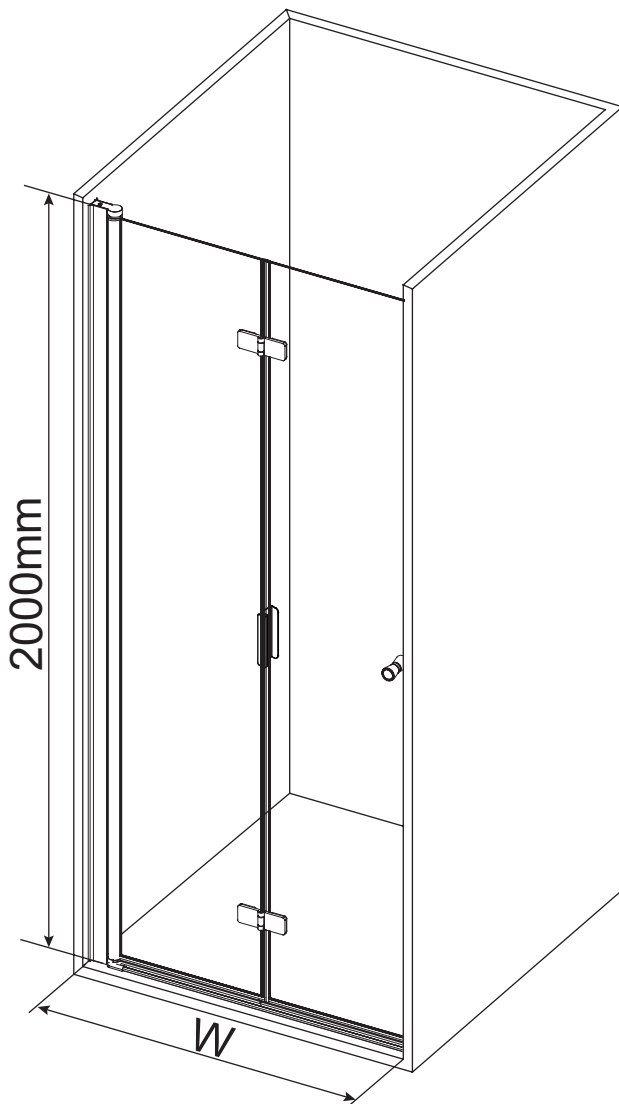

W:

800: 775 mm - 790 mm

900: 875 mm - 890 mm

1000: 975 mm - 990 mm

