



KTSP 010P (1000x2000)
KTSP 011P (1100x2000)
KTSP 012P (1200x2000)
KTSP 014P (1400x2000)
KTSP 016P (1600x2000)

KTSP N10P (1000x2000)
KTSP N11P (1100x2000)
KTSP N12P (1200x2000)
KTSP N14P (1400x2000)
KTSP N16P (1600x2000)

PL Instrukcja montażu
EN Assembly instructions
DE Montageanleitung
LV Instalēšanas instrukcijas
RU Инструкция по установке
UK Інструкція по установці
RO Instrucțiunile de instalare
HR Upute za montažu

FR Instructions d'installation
NO Installasjonsinstruksjoner
LT Instaliavimo instrukcijas
FI Asennusohjeet
SK Pokyny na inštaláciu
HU Telepítési utasítások
CS Pokyny k instalaci
SV Monteringsanvisning

PL Przed rozpoczęciem montażu należy sprawdzić czy towar nie posiada wad, oraz czy jest kompletny. Firma Deante sp. z o.o. nie ponosi odpowiedzialności za widoczne defekty produktu po jego montażu. Przed montażem szczyb należy wyczyścić okolice ich mocowań przy użyciu podstawowych środków czystości przeznaczonych do czyszczenia szkła. Do montażu zaleca się używania tylko i wyłącznie sylikonu sanitarnego. Po rozpakowaniu kabiny chronić szczyb przed uderzeniami podczas odkładania ich na podłóżce (np. odkładając je na karton). Unikać uderzeń o krawędzi szczyb bądź ich rogi.

EN Before starting the assembly, it is necessary to check whether or not a cubicle has defects and is complete. The company: Deante sp. z o.o. does not bear responsibility for noticeable defects of the product after its assembly. Before installation of panes, it is required to clean out places of their fixing with the use of basic cleaners intended for cleaning glass. For assembly it is advisable to use only sanitary silicone. After unpacking the cubicle, protect panes from hits while putting them on the surface (e.g. by putting them on a cardboard). Avoid hits on panes' edges or their corners.

DE Vor der Montage soll überprüft werden, ob die Ware mangelfrei und vollständig ist. Die Firma Deante sp. z o.o. haftet nicht für sichtbare Produktdefekte nach seiner Montage. Vor der Glasscheibenmontage sind die Stellen um die Befestigungen herum mit normalem Glasreiniger sauber zu machen. Es wird empfohlen, für die Montage nur Sanitär-Silikon zu verwenden. Nach der Auspackung der Kabine sollen die Glasscheiben vor Schlägen infolge des Ablegens auf den Boden (z.B. wenn die auf den Karton abgelegt werden) geschützt werden. Man soll vermeiden, gegen die Scheibenkanten bzw. -ecken zu schlagen.

LT Pirms sākt uzstādīšanu, pārbaudiet, vai precei nav defektu, un, vai tā ir nokomplektēta. Uzņēmums Deante sp. z o.o. neatbild par redzamiem produkta defektiem pēc montāžas. Pirms caurspīdīgo sienīņu uzstādīšanas, tās jānotīra ar stiprinājuma vietām, izmantotajam mazgāšanas līdzekļam, kas paredzēti stikla tīrīšanai. Uzstādīšanai ieteicams izmantot tikai un vienīgi sanitāro silikonu. Pēc kabīnes detaļu uzsaiņošanas sargāt caurspīdīgās sienīņas pret triecienu to novietojšanas laikā uz pamatnes (piem. novietojiet tās uz kartona kastes). Izvairieties no caurspīdīgo sienīņu malu vai stūru sasišanas.

RU Перед началом монтажа следует убедиться в наличии всех элементов и в отсутствии дефектов. Фирма Deante sp. z o.o. не несет ответственности за видимые дефекты изделия после его монтажа. Перед началом монтажа стекол следует очистить область их установки, при использовании основных моющих средств, предназначенных для чистки стекла. Для монтажа рекомендуется использовать только санитарный силикон. После распаковки кабины следует защитить стекла от ударов при откладывании их на пол (например, класть их на картон). Избегайте ударов о края стекол или об их углы.

UK Перед початком збірки і установки перевірити чи товар не має дефектів і чи повністю укомплектований Фірма Deante sp. z o.o. (Данте Антчак Повне товариство) не несе відповідальність за дефекти виробу, які проявилися після його монтажу. Перед монтажем скляних стінок необхідно вичистити зони їх кріплення за допомогою миючих засобів, призначених для миття скла. Для монтажу рекомендується використовувати тільки і виключно санітарний силікон. Після розпакування кабінки оберігати скляні елементи від ударів під час відкладання (напр. відкладення їх на картон). Уникайте ударів краями скла або їх кутами.

RO Înainte de începerea montajului trebuie verificat dacă marfa nu posedă defecte și dacă este completă. Firma Deante sp. z o.o. nu este responsabilă pentru defecte vizibile ale produsului după montajul acestuia. Înainte de montajul geamurilor trebuie curățate locurile de montare cu folosirea produselor de curățenie de bază, destinate curățării sticlei. Pentru montaj se recomandă folosirea exclusivă a siliconului sanitar.

După despachetarea cabinei, protejați geamurile împotriva impactului în timpul așezării lor pe podea (plasându-le de exemplu pe carton). Evitați loviriile marginilor sau colțurilor acestora.

HR Prije početka montaže provjeriti da li je proizvod kompletn i da li nema ikakvih nedostataka. Tvrtka Deante sp. z o.o. ne snosi odgovornost za vidljive nedostatke na proizvodu nakon montaže istog. Prije montaže stakala potrebno je pažljivo očistiti mjesto na kojima će stakla biti montirana, pomoću uobičajenih sredstava za čišćenje stakla. Za izvođenje montaže preporučuje se isključivo sanitarni silikon. Nakon raspakiranja kabine potrebno je zaštititi stakla od oštećenje npr. prilikom stavljanja ih na pod – treba prethodno zaštititi pod kartonom. Treba izbjegavati udaranja u ivice ili uglove stakala.

FR Avant de commencer l'installation vérifiez si la marchandise est sans défauts et si elle est complète. La société Firma Deante sp. z o.o. se décline de toute responsabilité des défauts visibles apparus après l'installation. Avant l'installation nettoyez les surfaces de fixation avec des produits de nettoyage pour le verre. Pour l'installation utilisez uniquement le silicone sanitaire. Après le déballage de la cabine protégez les vitrages contre le choc lorsqu'elle est posée sur le sol (posez les vitrages sur un carton). Évitez les chocs pouvant affecter les vitrages ou leurs bordos.

NO Før oppstart av monteringen, sjekk om varen ikke har feil og om settet er komplett. Selskapet Deante sp. z o.o. tar ikke ansvar for synlige produktfeil etter at produktet er montert. Før monteringen av glass skal festepunkter rengjøres ved hjelp av vanlige vaske-midler til rengjøring av glass. Til monteringen bør kun sanitært silikone brukes. Etter utpakkning av kabinettet, beskytt glasset mot slag, mens du legger det på gulvet (legg glass på kartong). Unngå slag på glasskanten eller glasshjørnet.

LV Prieš pradėdant montuoti kabina, pirmiausia reikia patikrinti ar prekė neturi trūkumų, ir ar yra pilnai sukomplektuota. Firma Deante sp. z o.o. nepiima atsakomybės už akivaizdžius gaminio defektus po jo montavimo. Prieš atliekant montavimo darbus būtina išvalyti tvirtinamąsias vietas naudojant valymo priemones skirtas stiklams valyti. Montavimui rekomenduojama naudoti veini tikai sanitarinį silikoną. Išėmus kabina iš pakuotės būtina saugoti kabinos stiklus nuo sutrenkimų ypaė dedant juos ant grindinio (pav. patiesiant po jais kartono lakštus). Būtina stengtis išvengti stiklų kraštų ar kampų sutrenkimų.

FI Ennen asennuksen aloittamista tulee tarkistaa, onko tavaraa vikoja sekä onko tavara täydellinen. Deante sp. z o.o. ei ole vastuussa tuotteen olevista näkyvistä vioista sen asennuksen jälkeen. Ennen suihkukaabin lasien asennusta niiden tulee kiinnityskohdan alueet puhdistaa käyttäen lasin puhdistukseen tarkoitettuja peruspuhdistusaineita. Asennukseen suositellaan käytettäväksi vain ja ainoastaan saniteettisilikonit. Suihkukaabin pakkauksesta purkamisen jälkeen lasit tulee suojata iskulla vastaan niiden alustalle asentamisen aikana (esim. suojaamalla ne pahvilla). Vältä iskuja levyjen reunoihin tai kulmiin.

SK Pred montážou skontrolujte, či tovar nie poškodený, a či je kompletný. Firma Deante sp. z o.o. nenesie žiadnu zodpovednosť za vady viditeľné na produkte po jeho namontovaní. Skla v blízkosti miest ich upevnenia pred montážou vyčistite pomocou základných čistiacich prostriedkov určených na čistenie skla. Na montáž používajte výlučne sanitárny silikón. Po rozbalení kabíny chráňte sklá pred nárazmi, ku ktorým môže dochádzať pri ich odkladaní (napr. pri ich odkladaní na kartóne). Vyhnite sa nárazom do hrán alebo rohov skiel.

HU Összeszerelés előtt ellenőrizze, hogy az áru minden eleme sérülésmentes legyen és megtalálható a csomagolásban. A Deante sp. z o.o. nem vállalja a felelősséget az összeszerelés után észlelt sérülésekért. Az üveg szerelése előtt tisztítsa meg az üvegszerelés helyeit normál üveg tisztító szerrel. A szerelésnél csak és kizárólag szaniter szilikont használjon. Miután kicsoma golta a kabinát átrakodás közben védje az üveget az esetleges ütésektől (pl. kartonpapírra rakás közben). Vigyázzon szélekre és a sarkokra.

CS Před zahájením montáže zkontrolujte zboží, jestli nemá vady a jestli je kompletní. Firma Deante sp. z o.o. nenese zodpovědnost za viditelné defekty produktu po jeho montáži. Před montáží skel vyčistěte okolí jejich připevnění za použití základních čistících prostředků určených k čištění skla. K montáži se doporučuje používat jen a výhradně sanitární silikon. Po rozbalení sprchového koutu chráňte skla před úderem během jejich odkládání na podklad (např. je odložte na kartón). Vyvarujte se úderů o hrany skel nebo jejich rohy.

SV Innan monteringen påbörjas ska man kontrollera att varan inte är defekt och att den är komplett. Deante sp. z o.o. ansvarar inte för synliga fel på produkten efter att den har monterats. Innan monteringen av rutorna ska man rengöra området kring deras fästen med vanligt glasrengöringsmedel. Det rekommenderas att man enbart använder sanitetssilikon vid monteringen. Efter att kabinen packats upp ska rutorna skyddas mot stötar då de läggs ner på underlaget (de kan t.ex. läggas på kartong). Undvik att stöta rutornas kanter eller hörn.

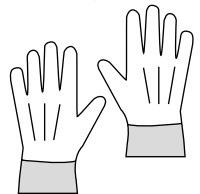
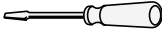
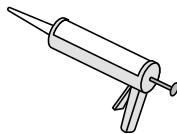

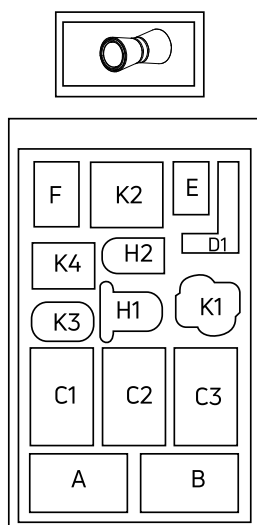
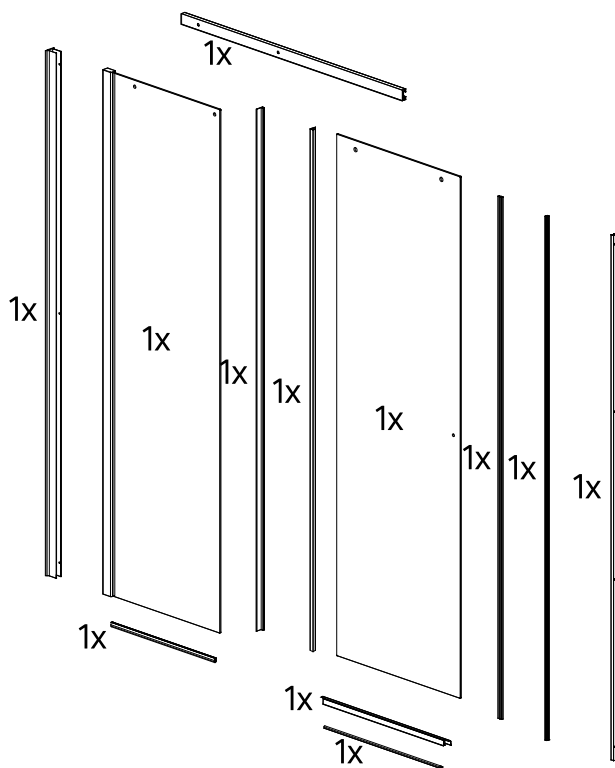

	x1		H1	x1	
A	x2		H1	x3	
B	x1		K1	x2	
B	x2		K2	x1	
C1	x10		K3	x1	
C2	x1		K3	x1	
C2	x1		F	x1	
C2	x3		K4	x1	
C3	x11		D1	x2	
E	x1		D1	x1	
H2	x1				



A	x1	
B	x1	
C	x2	 ST3.5X9.5

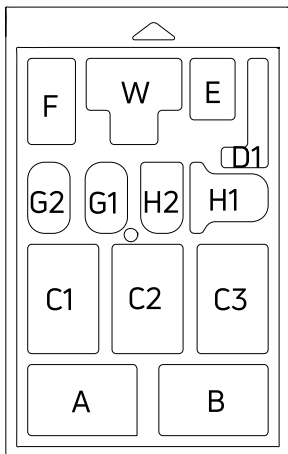
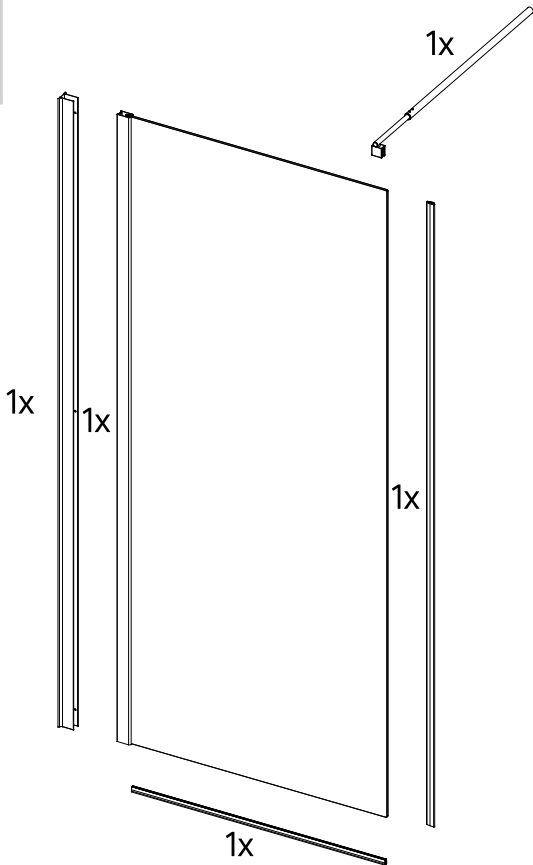

A	x2		G1	x1	
H1	x2		H2	x1	
B	x4		C2	x1	
B	x6		G2	x3	
E	x1		C1	x3	
F	x1		W	x1	
C3	x1		D1	x1	
C3	x1		D1	x1	



X1 P6-P24

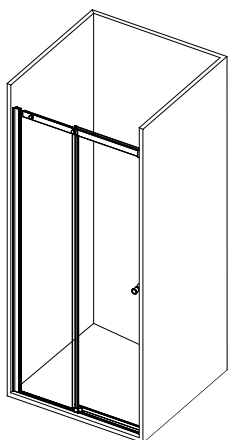

X1 P25-P43

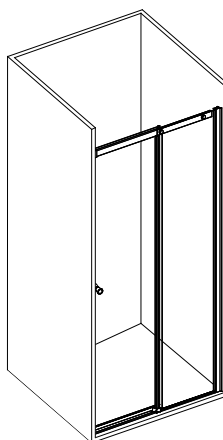

+



+



P44-P60

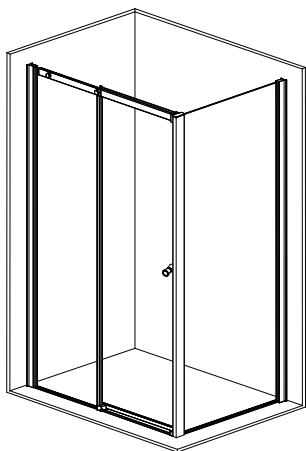



W:

1000	985mm-1000mm
1100	1085mm-1100mm
1200	1185mm-1200mm
1300	1285mm-1300mm
1400	1385mm-1400mm
1500	1485mm-1500mm
1600	1585mm-1600mm

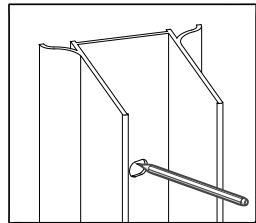
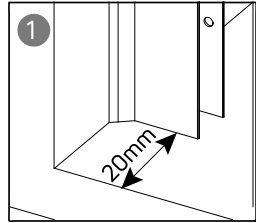

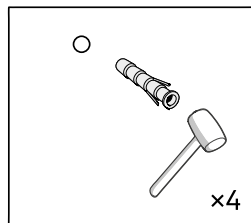
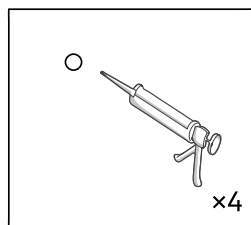
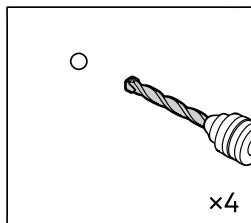
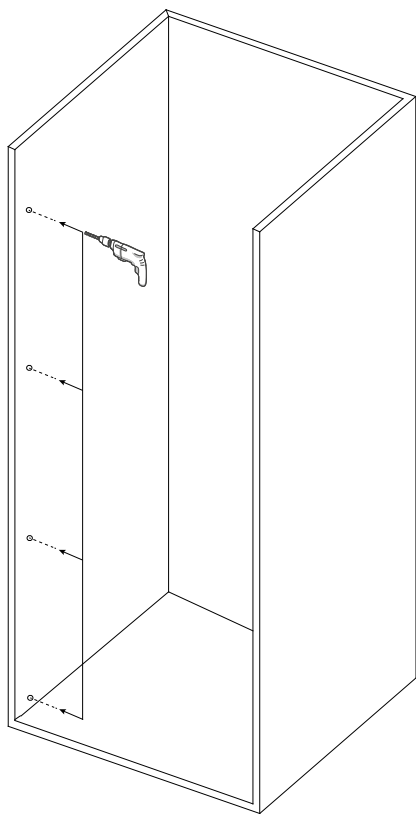

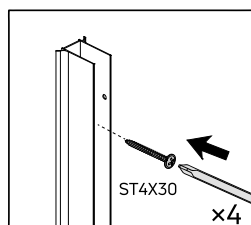
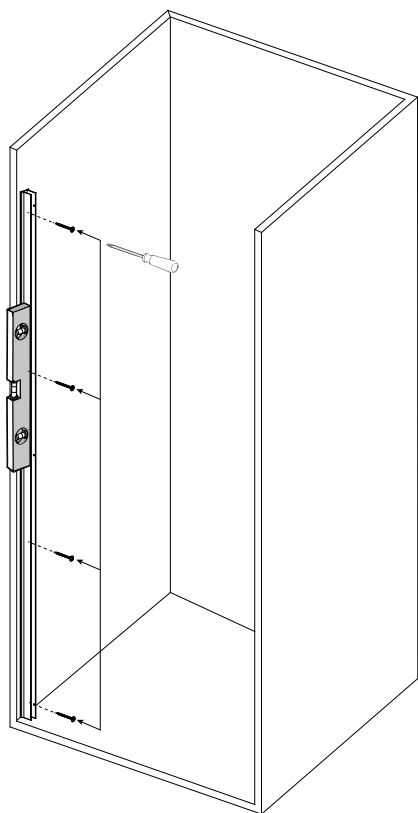

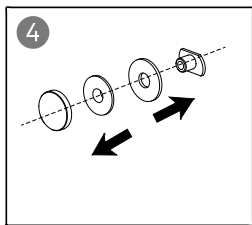
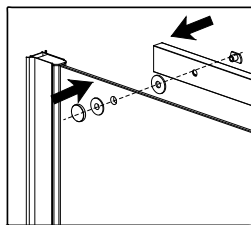
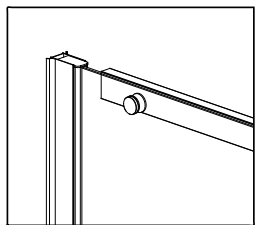
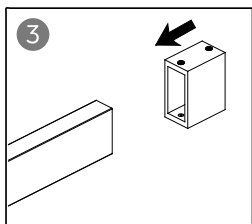
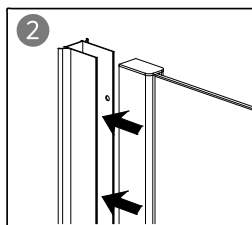
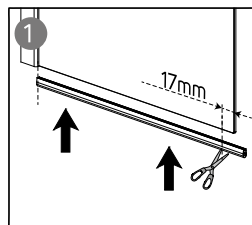
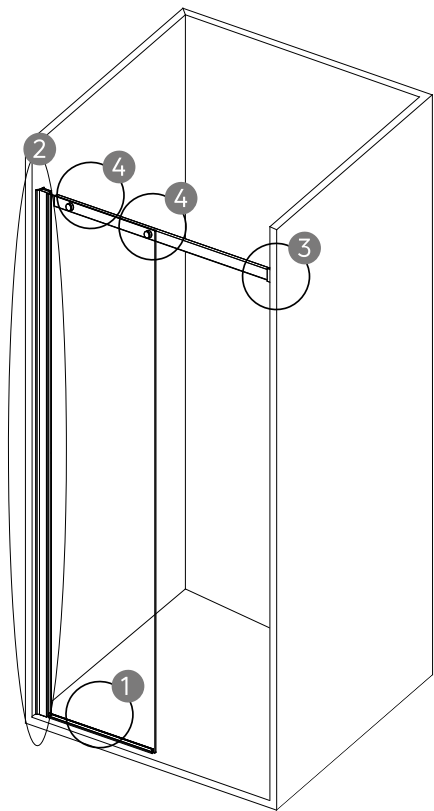

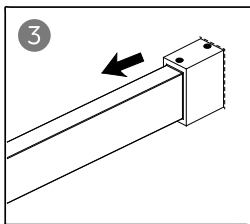
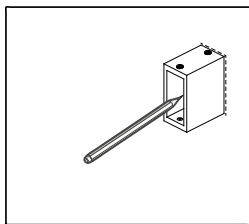
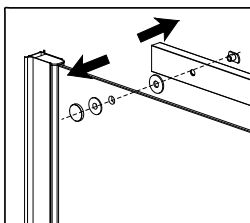
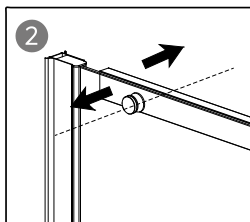
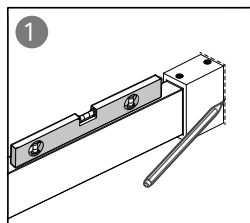
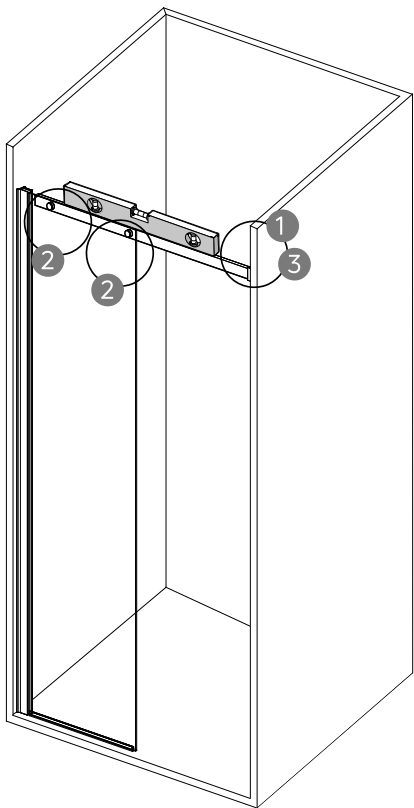

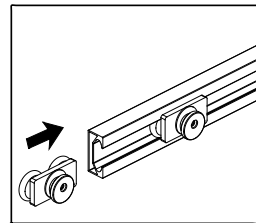
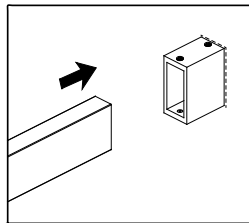
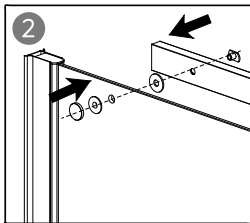
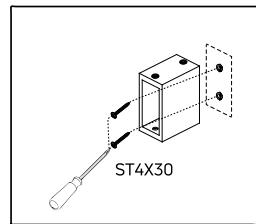
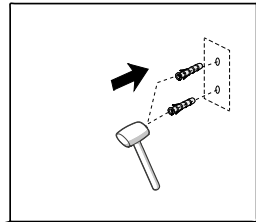
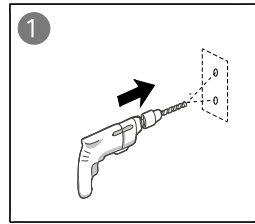
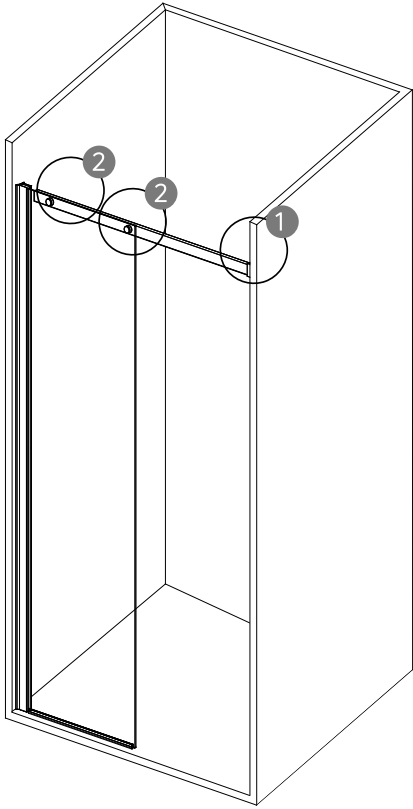

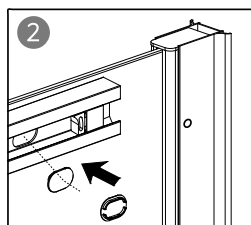
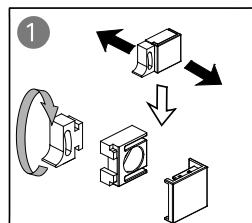
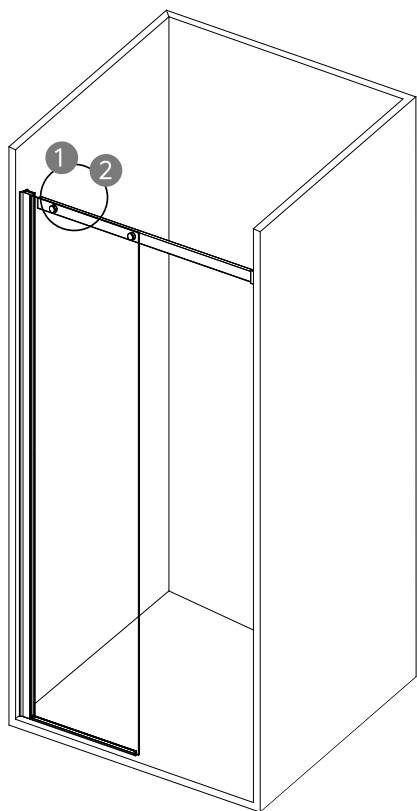

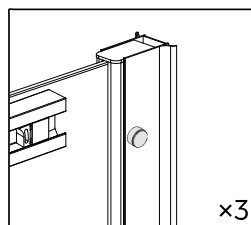
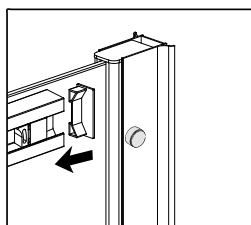
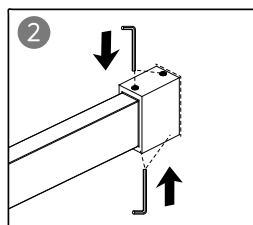
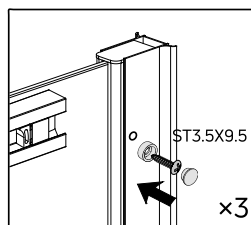
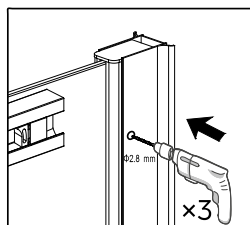
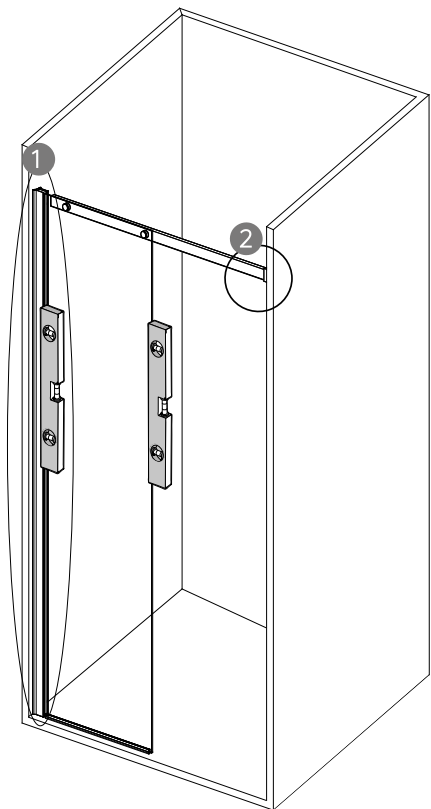

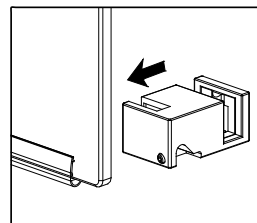
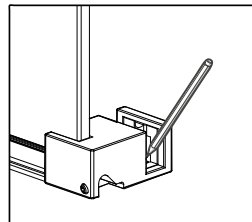
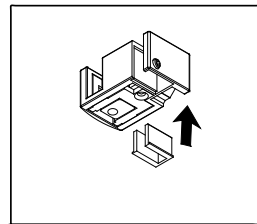
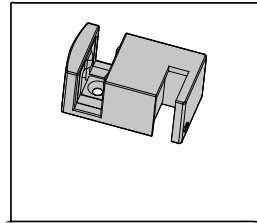
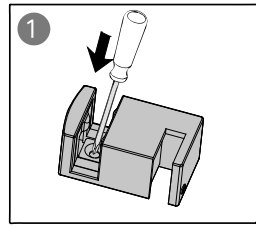
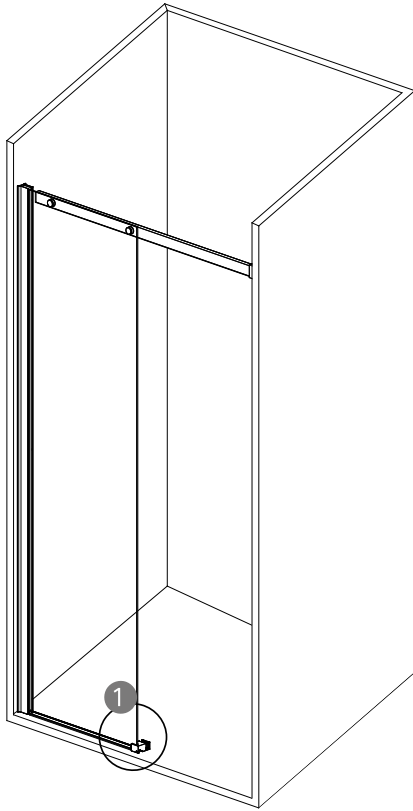

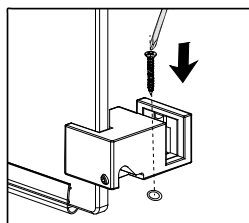

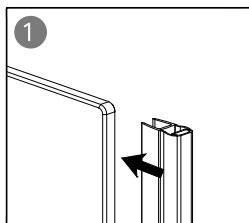

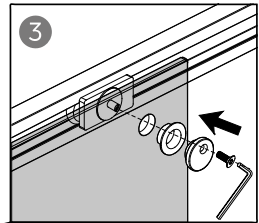
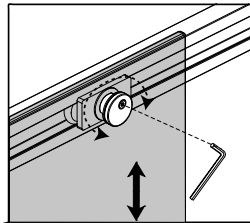
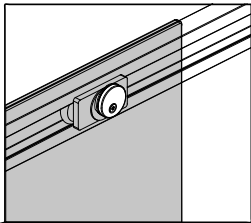
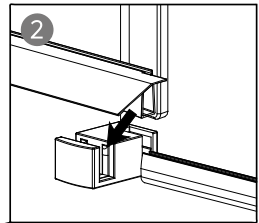
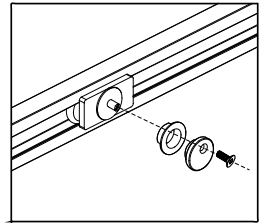
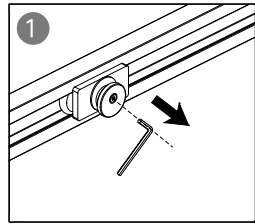

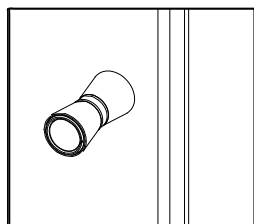
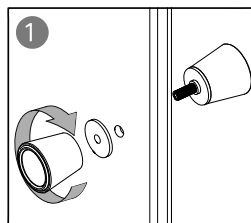
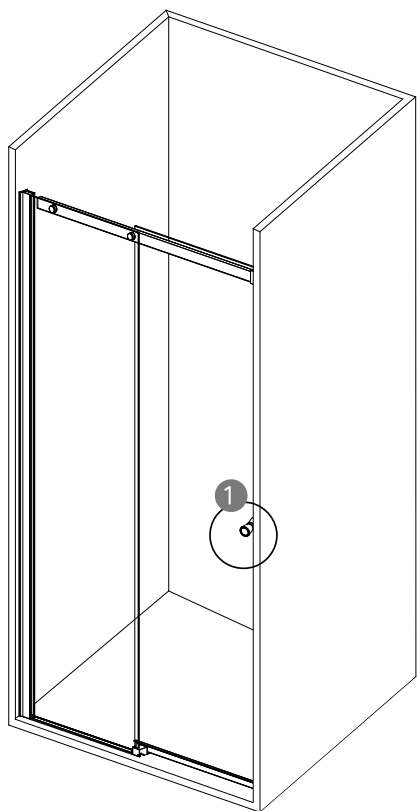

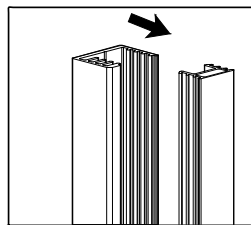
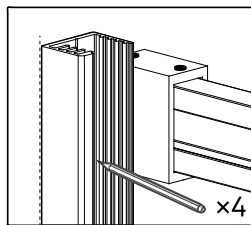
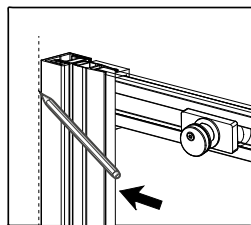
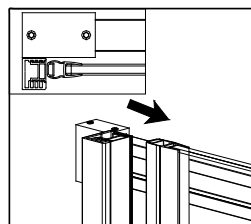
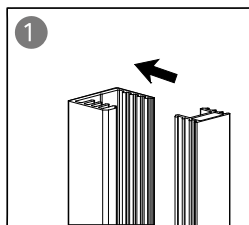
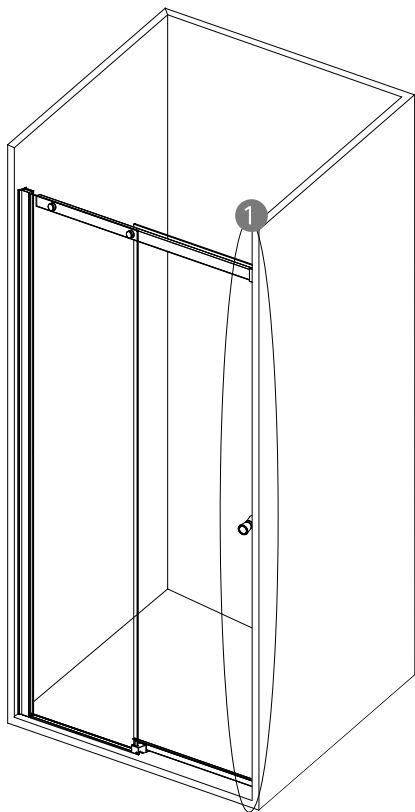

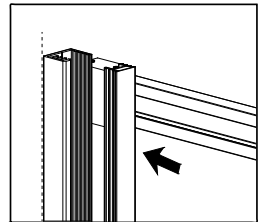
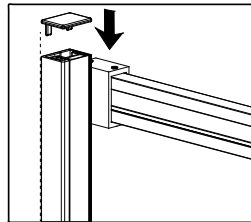
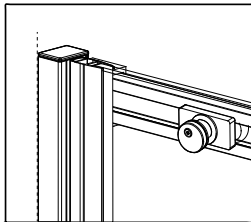
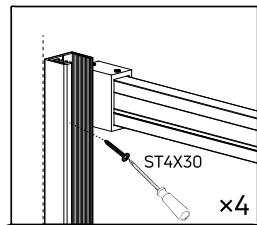
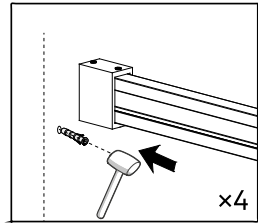

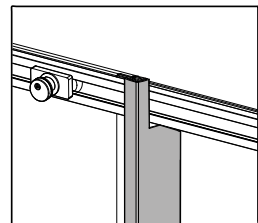
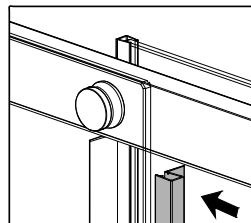
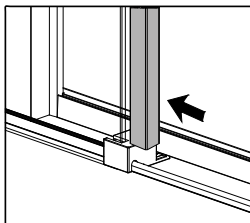
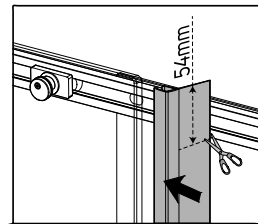
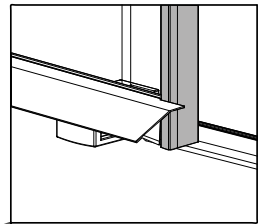
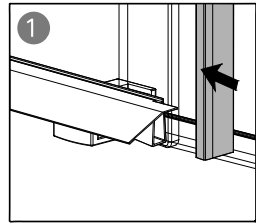

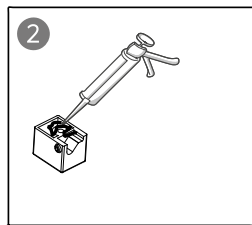
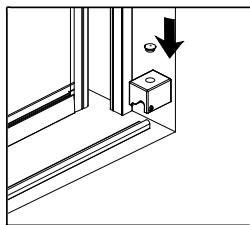
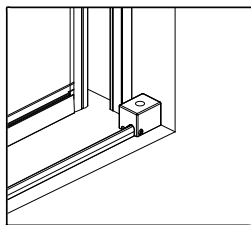
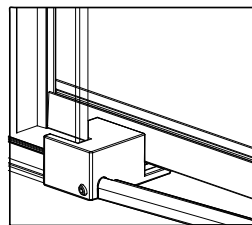
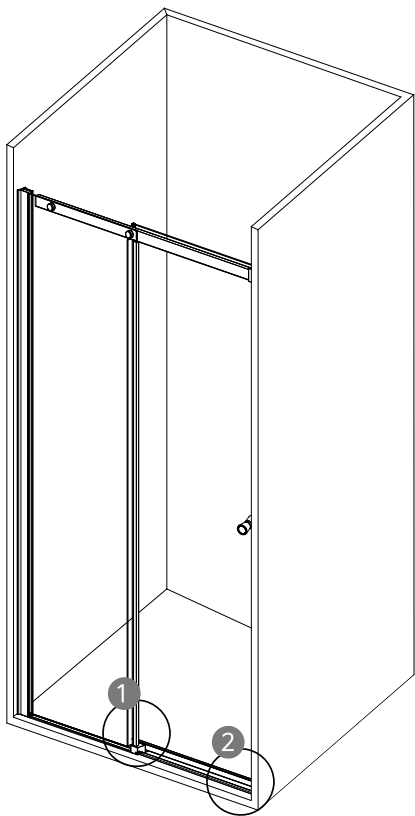

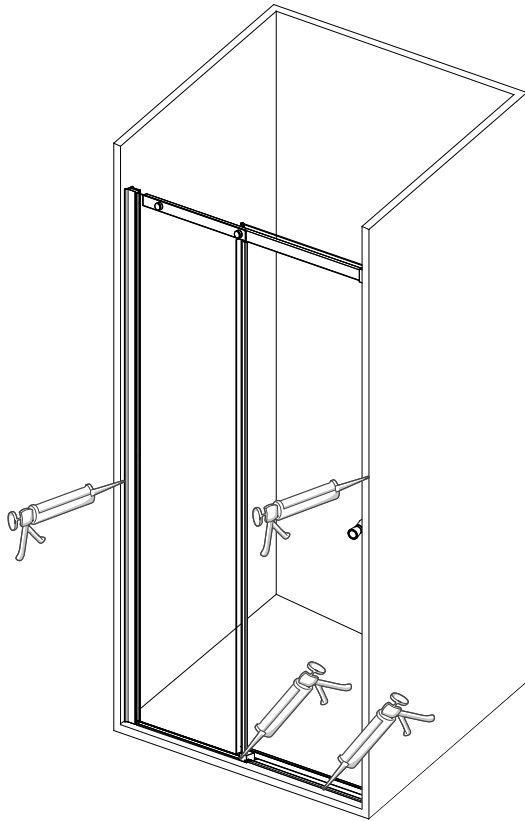



W:

1000	985mm-1000mm
1100	1085mm-1100mm
1200	1185mm-1200mm
1300	1285mm-1300mm
1400	1385mm-1400mm
1500	1485mm-1500mm
1600	1585mm-1600mm

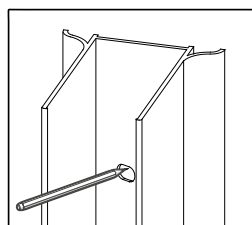
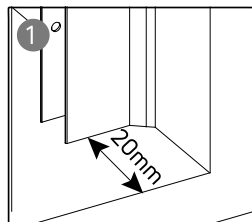
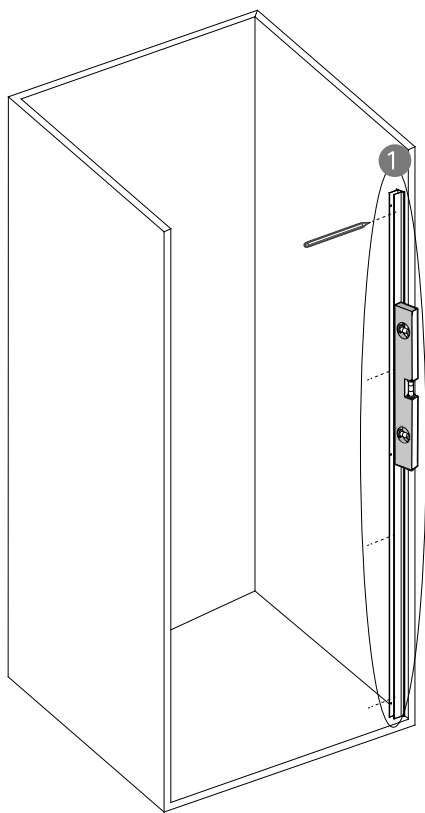

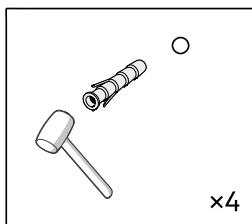
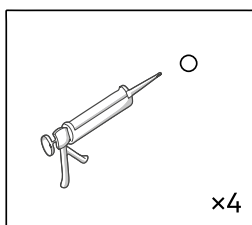
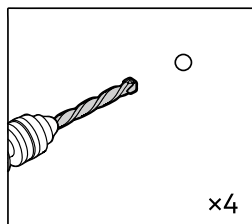
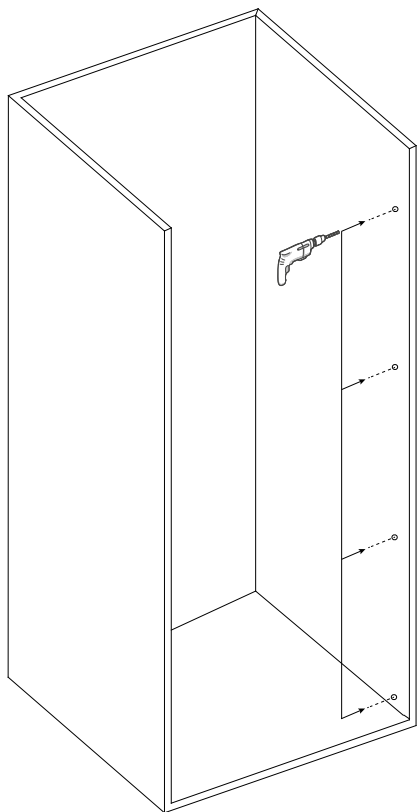

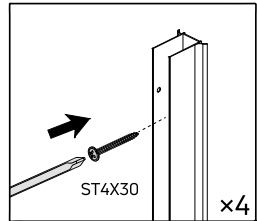



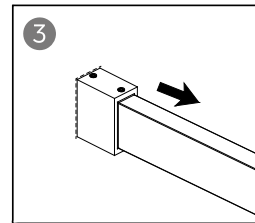
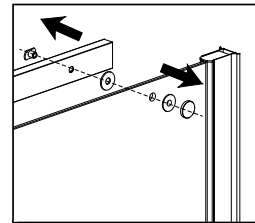
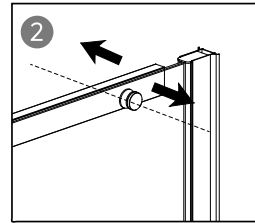
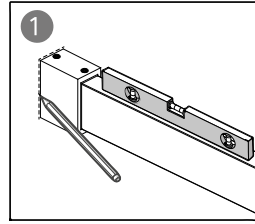

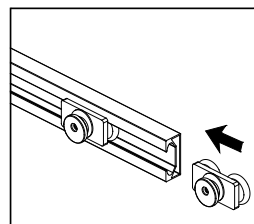
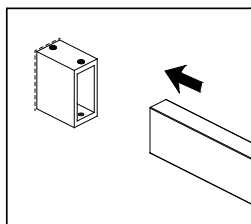
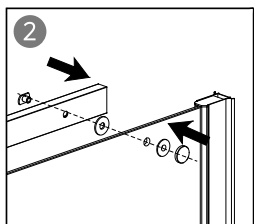
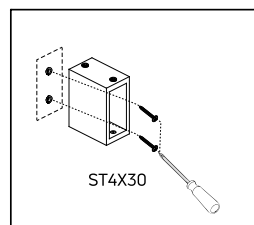
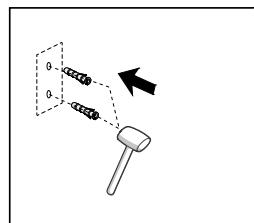
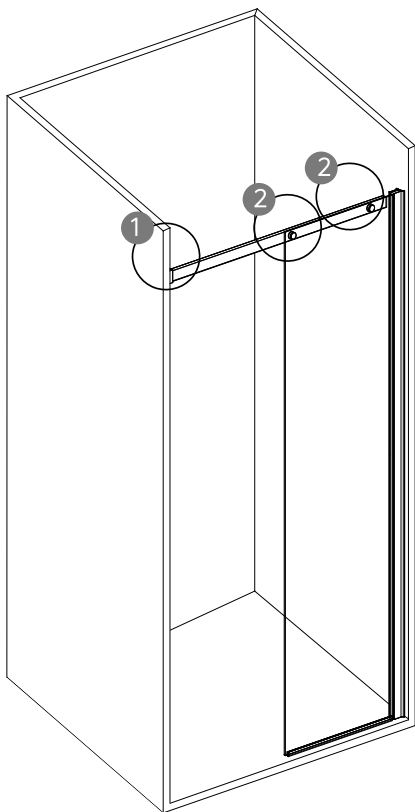

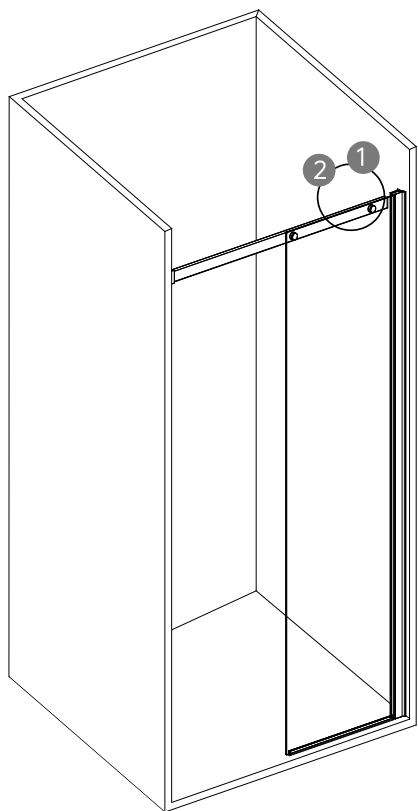

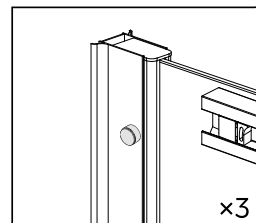
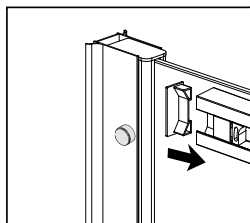
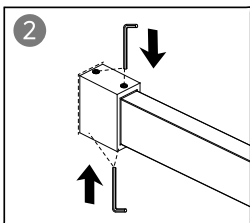
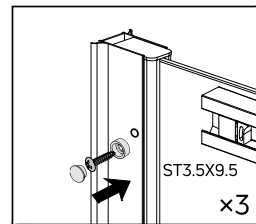
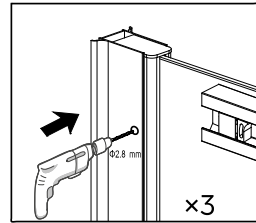
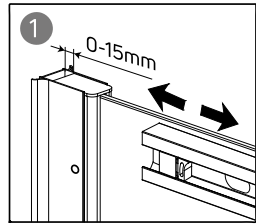
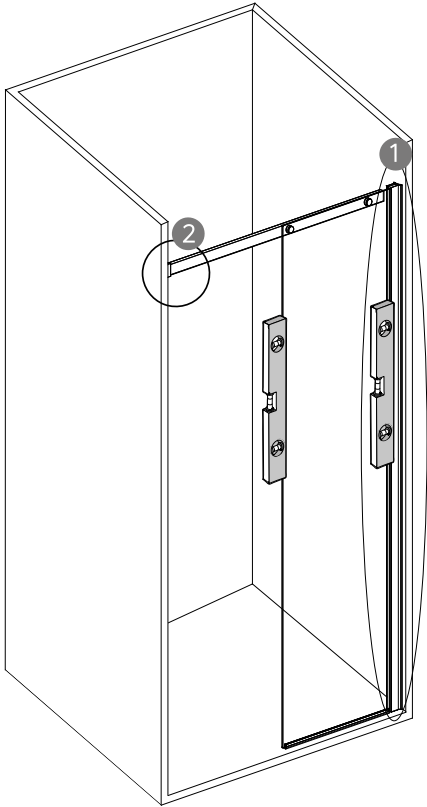

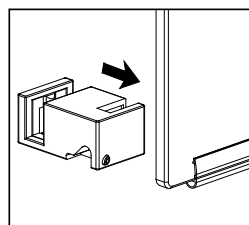
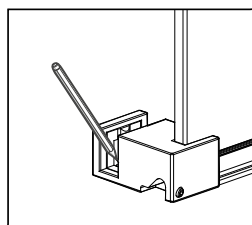
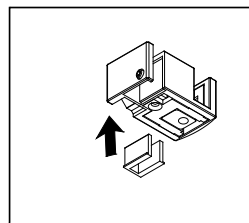
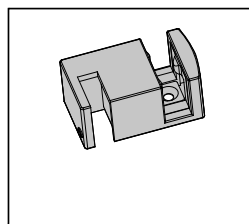
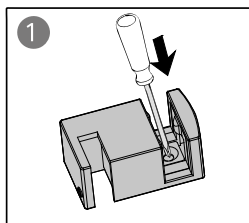
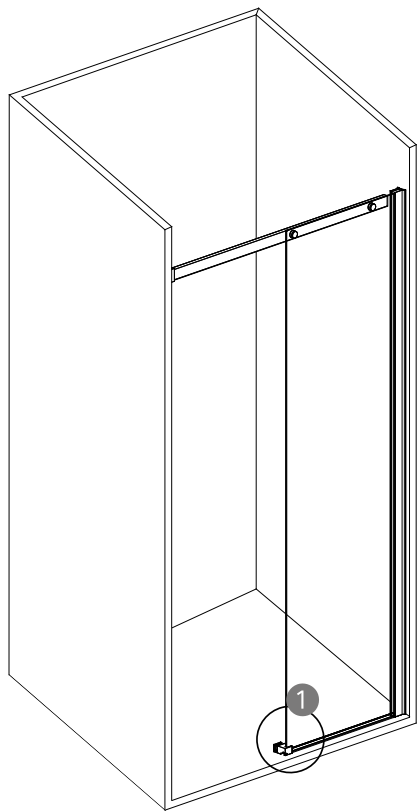

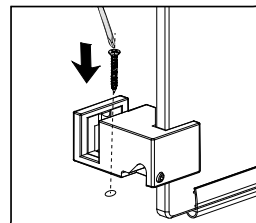
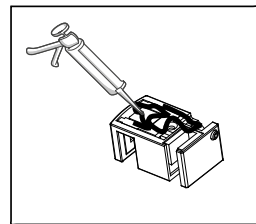
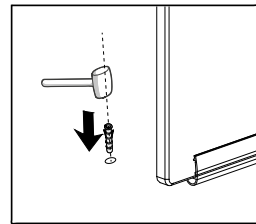
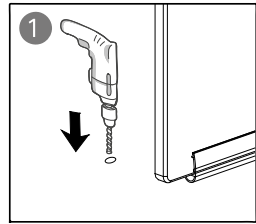
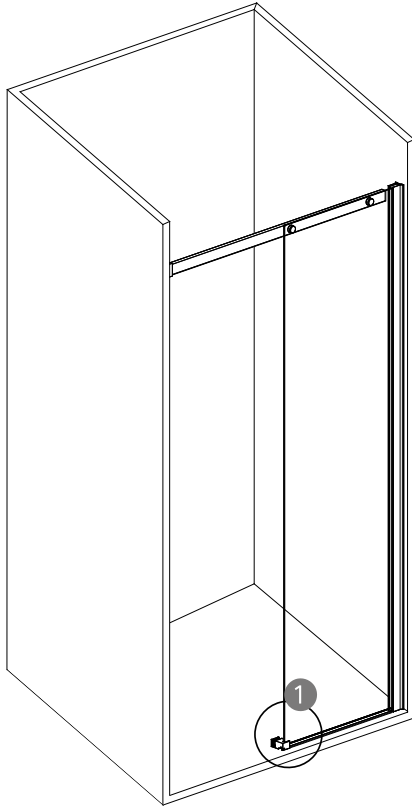

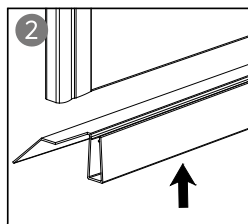
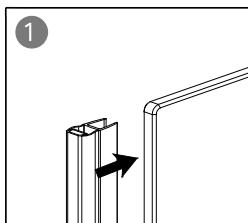

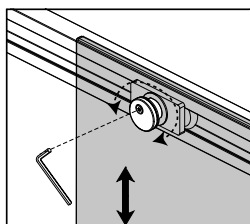
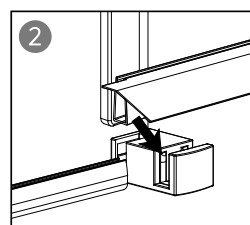
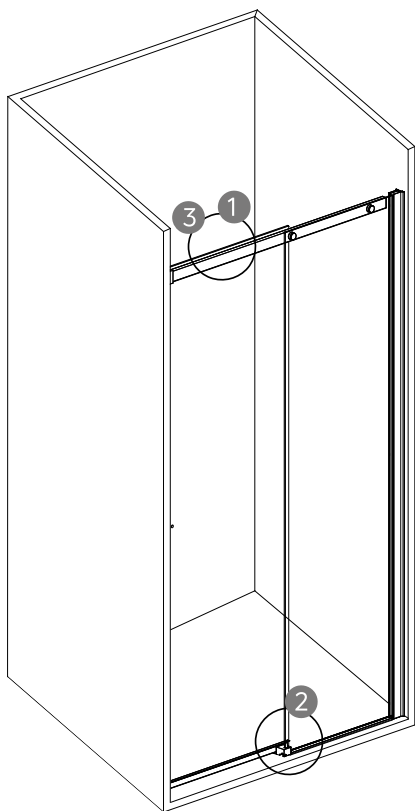

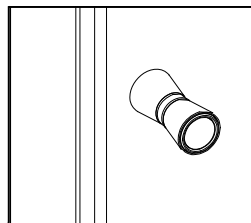
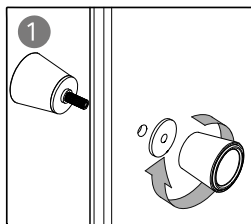
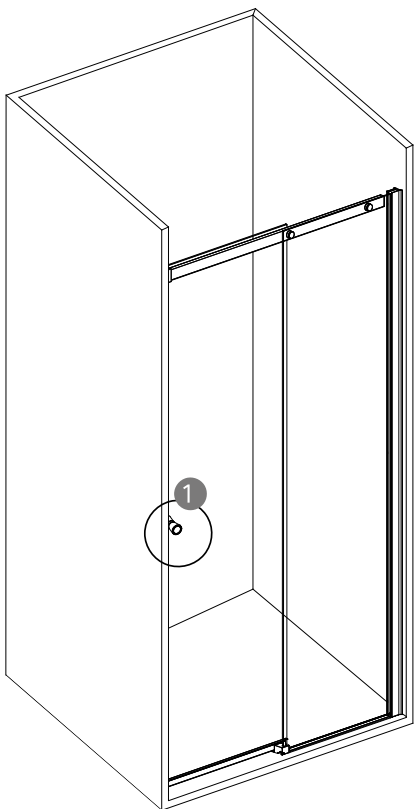

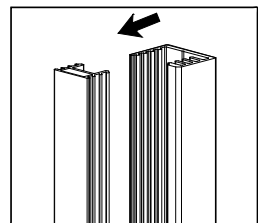
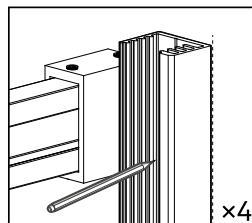
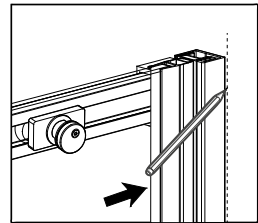
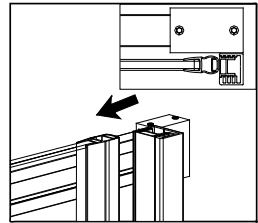
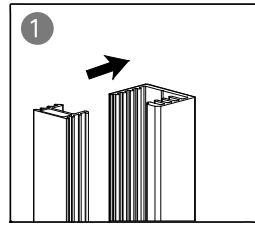

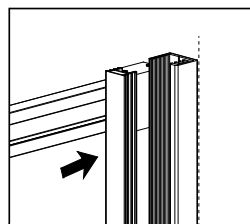
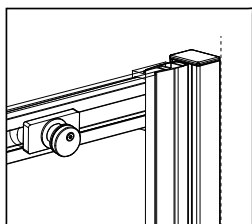
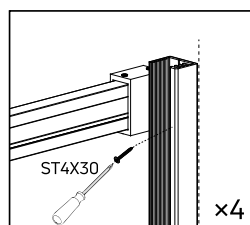
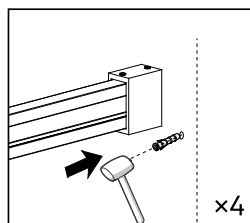
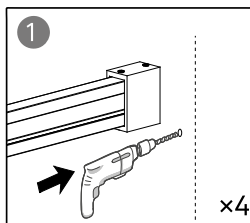
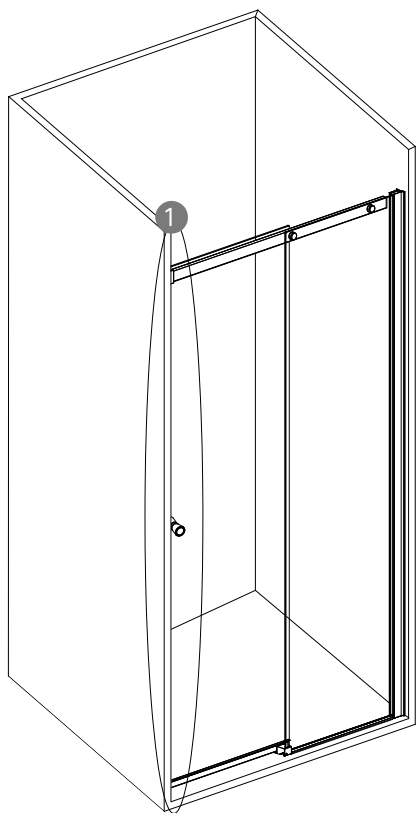

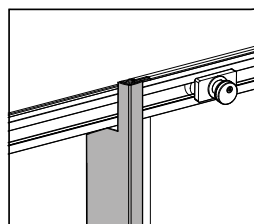
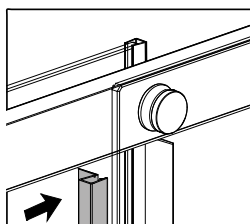
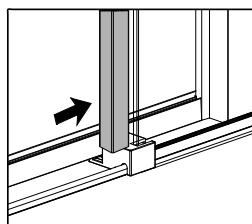
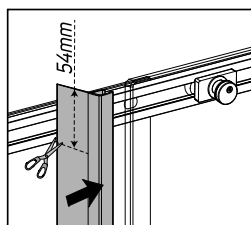
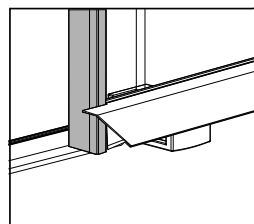

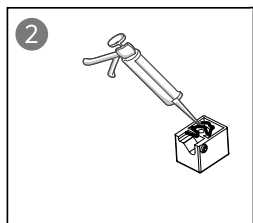
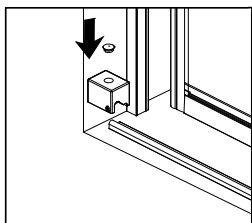
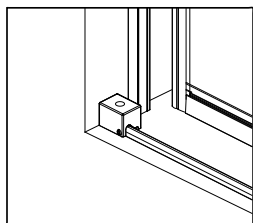
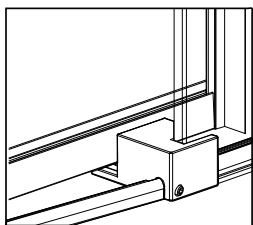
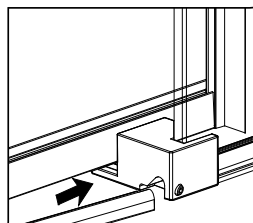
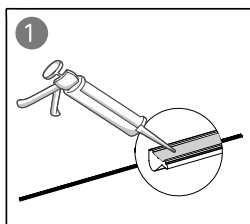
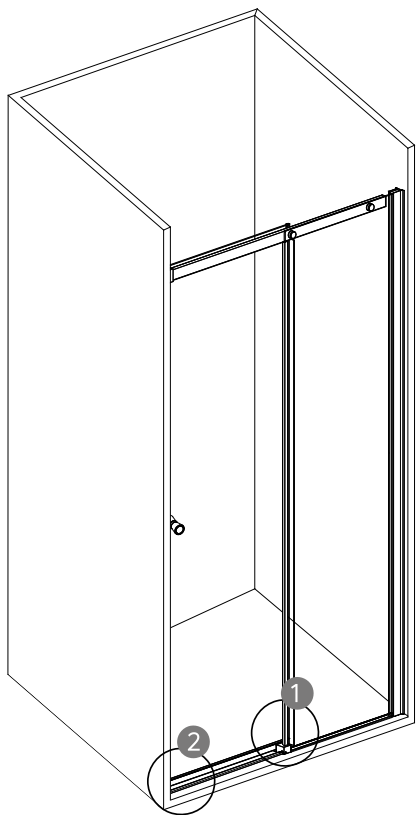



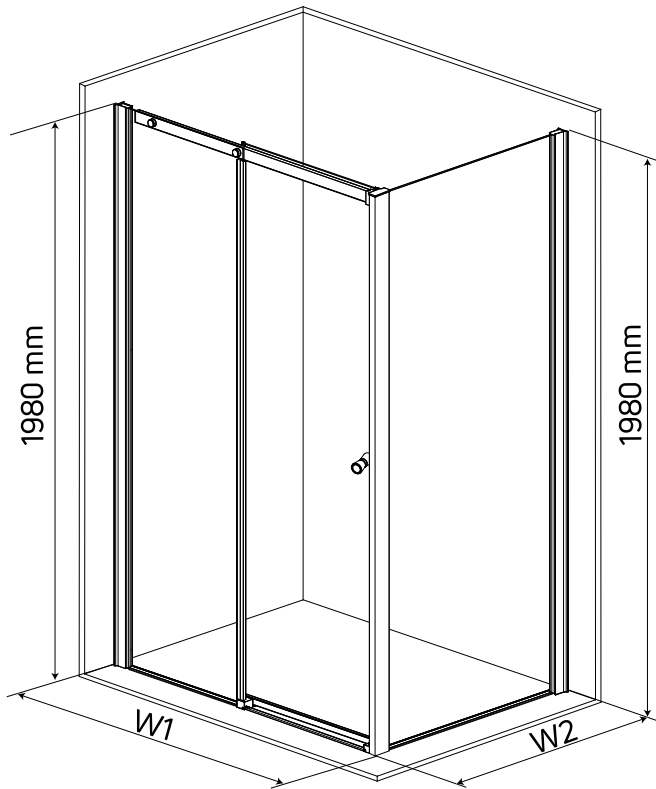

W1		W2	
1000	1015mm-1030mm	300	285mm-300mm
1100	1115mm-1130mm	400	385mm-400mm
1200	1215mm-1230mm	700	685mm-700mm
1300	1315mm-1330mm	800	785mm-800mm
1400	1415mm-1430mm	900	885mm-900mm
1500	1515mm-1530mm	1000	985mm-1000mm
1600	1615mm-1630mm	1100	1085mm-1100mm
		1200	1185mm-1200mm
		1400	1385mm-1400mm



