

Seria Rols

Drzwi wnękowe / Kabina prostokątna

Instrukcja montażu
Installation instructions
Montážní návod

Zeskanuj kod
i zobacz instrukcję
montażu na

YouTube

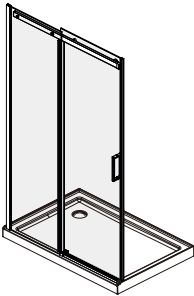

KAEX.2612 - str. 4

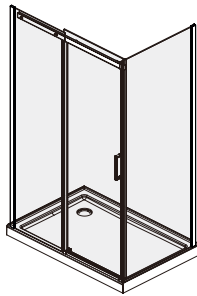

KAEX.2606 - str. 10



Caution

Możliwość montażu na płytkach lub na brodziku. Wymagana szerokość rantu brodzika lub szerokość płytki: minimum 80mm.

Can be installed on tiles or on a shower tray. Required width of the shower tray edge or tile width: minimum 80mm.

Lze namontovat na dlaždice nebo na sprchovou vaničku. Požadovaná šířka okraje vaničky nebo šíře obkladu: minimálně 80 mm.



WAŻNE!

Przed rozpoczęciem montażu uważnie przeczytaj instrukcję. Zanim rozpoczniesz montaż dokładnie sprawdź swój produkt. Zamontowanie produktu z widoczną wadą powoduje utratę gwarancji.

UWAGA!

Aby zapobiec przeciekaniu wody silikon należy nałożyć na zewnętrznej stronie parawanu, a nie wewnątrz! Zachowaj tę instrukcję na przyszłość.

IMPORTANT!

Read all instructions carefully before starting the installation. Thoroughly inspect your product before proceeding with the installation. The warranty will be void if the product is installed with a conspicuous defect.

CAUTION!

To prevent leaks, silicone must be applied on the outside of the bathscreen and not on the inside! Save this manual for future reference.

DŮLEŽITÉ!

Před zahájením montáže si pozorně přečtěte návod. Před zahájením montáže zkontrolujte důkladně výrobek.

Namontování výrobku s viditelnou vadou způsobí ztrátu záruky.

POZOR!

Pro zabránění protékání vody, naneste silikon na vnější, nikoli vnitřní stranu zástěny! Tento návod si uschovejte pro budoucí použití.

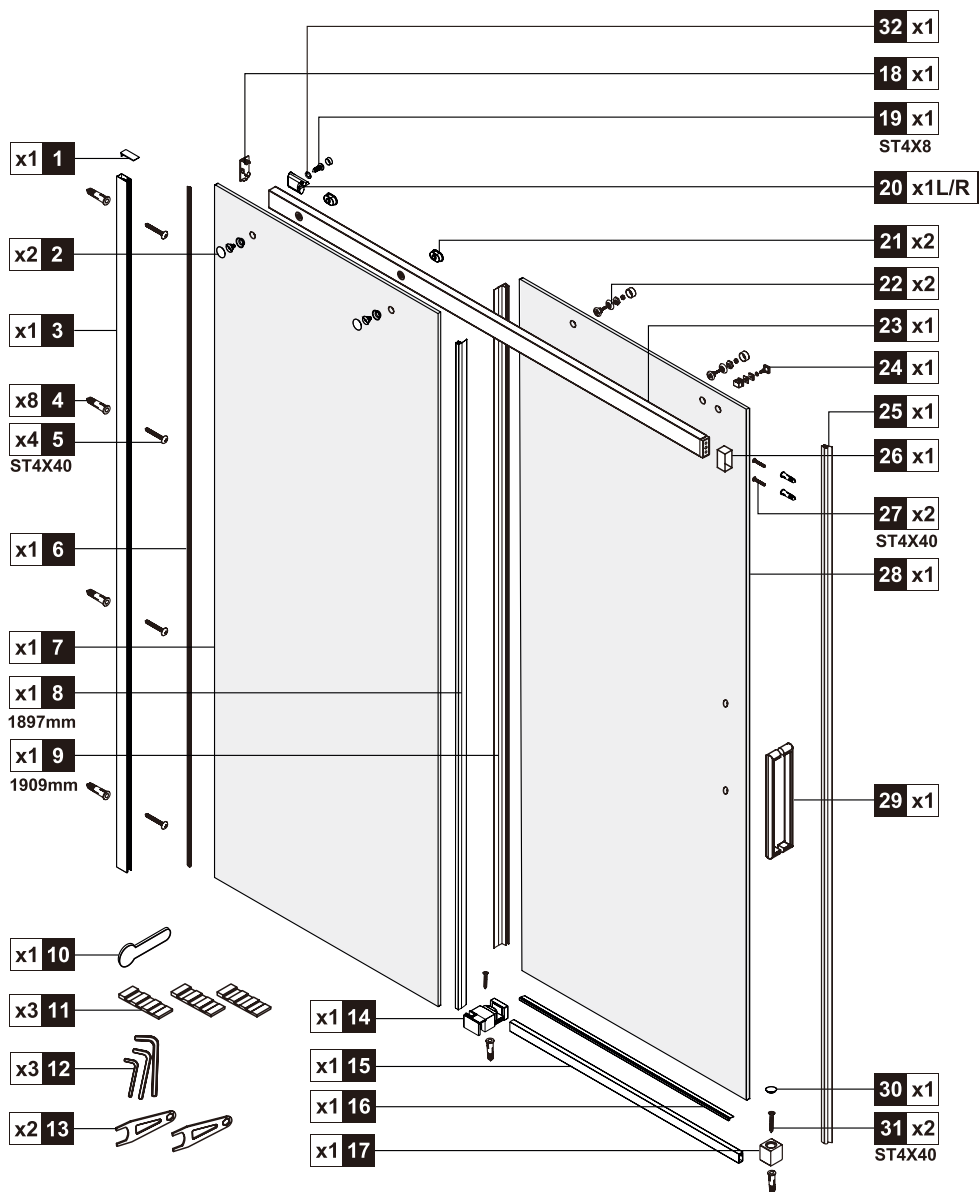

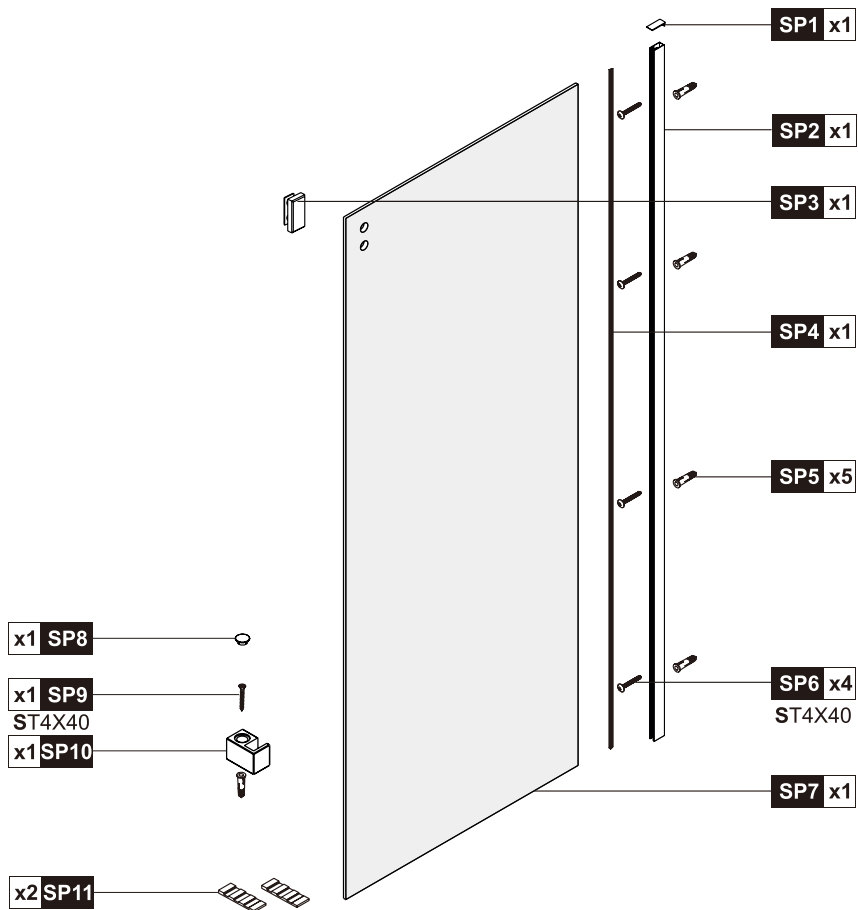

Przekrój / Cross-section / Průřez

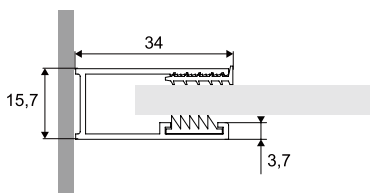

Przekrój profilu ścianki
Wall profile cross-section
Sténové profily průřez

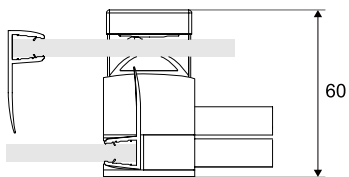

Przekrój dolnego systemu przesuwnego
Cross-section of bottom sliding system
Průřez spodním posuvným systémem

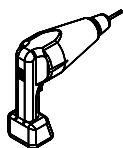

WIERTARKA

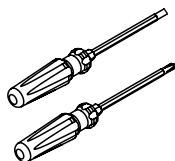

ŚRUBOKRĘT

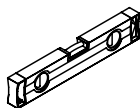

POZIOMICA

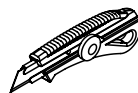

NÓŻ



SILIKON

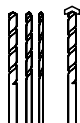

WIERTŁO: 1/8", 3/16" ET 1/4"
*WIERTŁA MURARSKIE

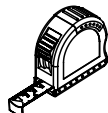

TAŚMA MIERNICZA



KAŹOWNICA



OLÓWEK



MŁOTEK

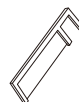

PIŁA

A 01 **KAEX.2612**

1000mm (970mm~1000mm)
1200mm (1170mm~1200mm)
1300mm (1270mm~1300mm)
1400mm (1370mm~1400mm)
1600mm (1570mm~1600mm)
1800mm (1770mm~1800mm)

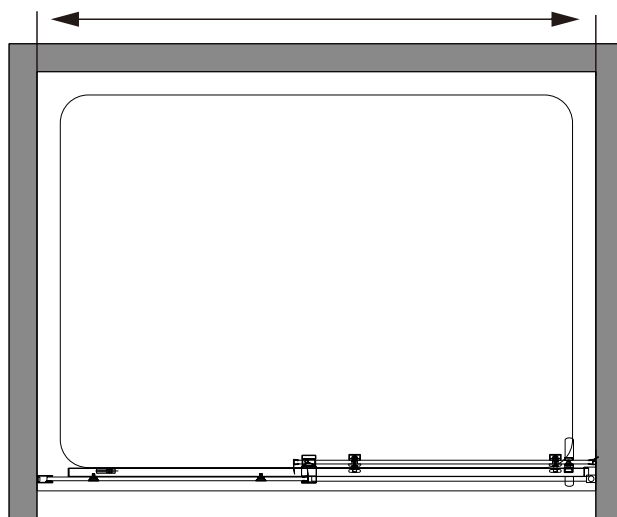

A 02

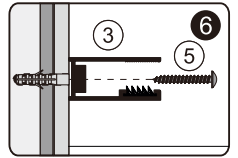
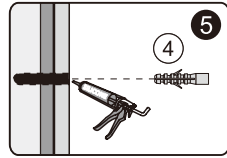
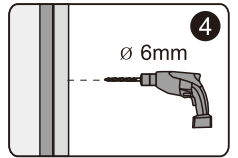
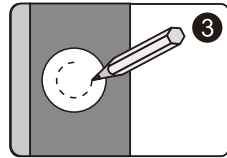
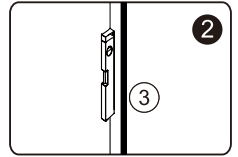
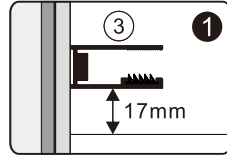
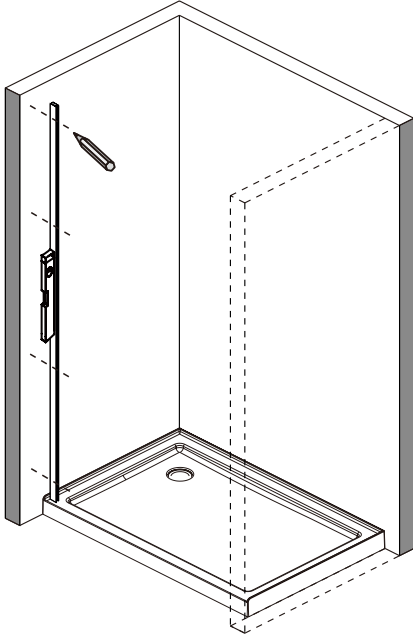

A 03

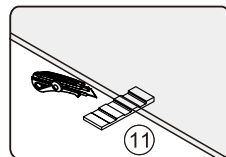
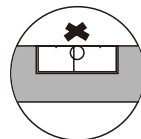
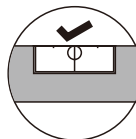
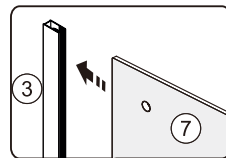
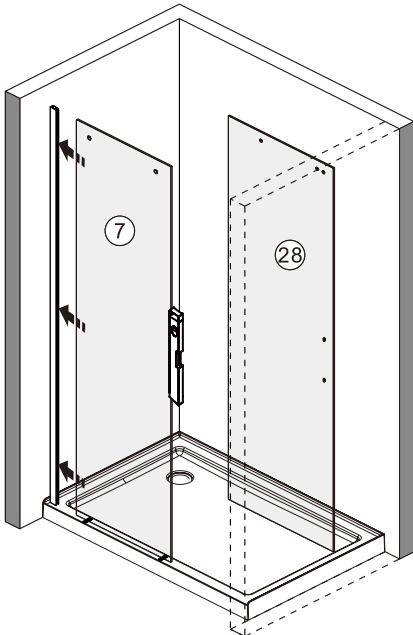

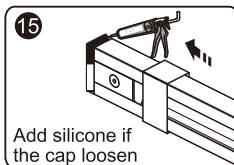
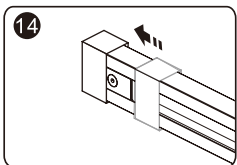
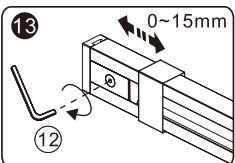
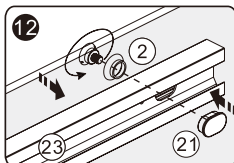
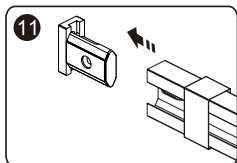
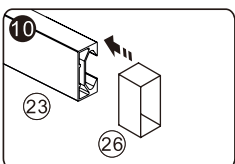
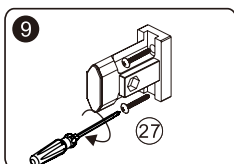
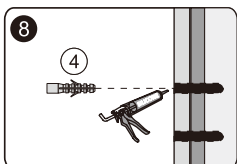
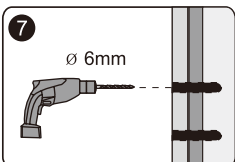
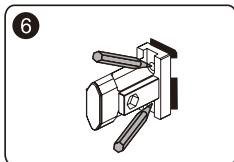
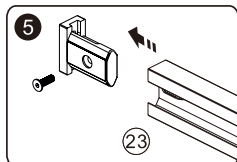
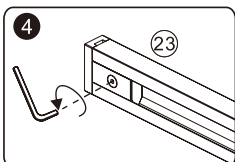
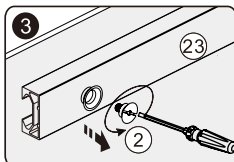
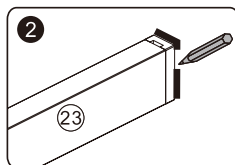
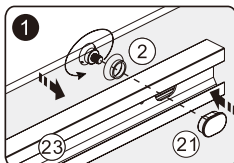
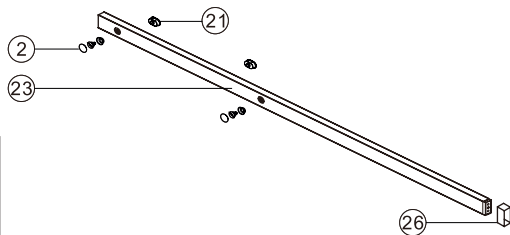
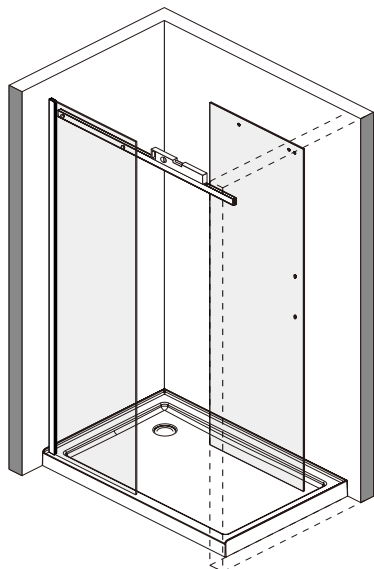

Add silicone if the cap loosens

A 05

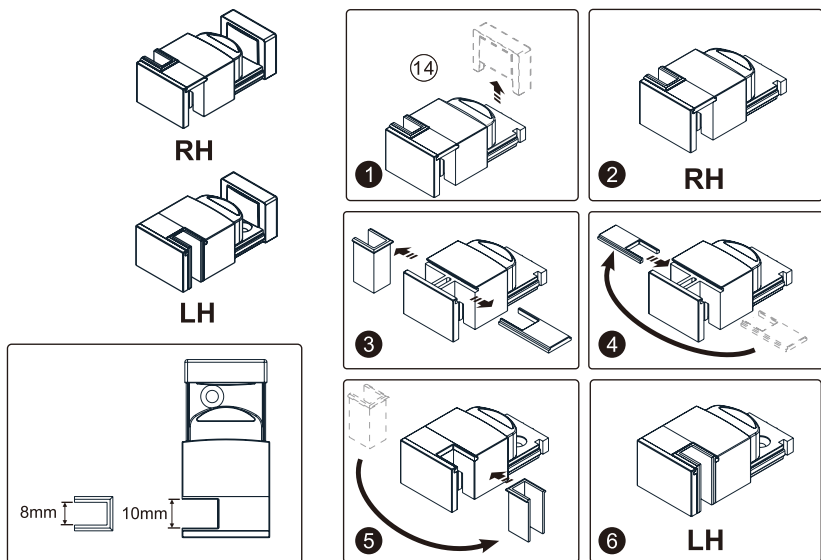

A 06

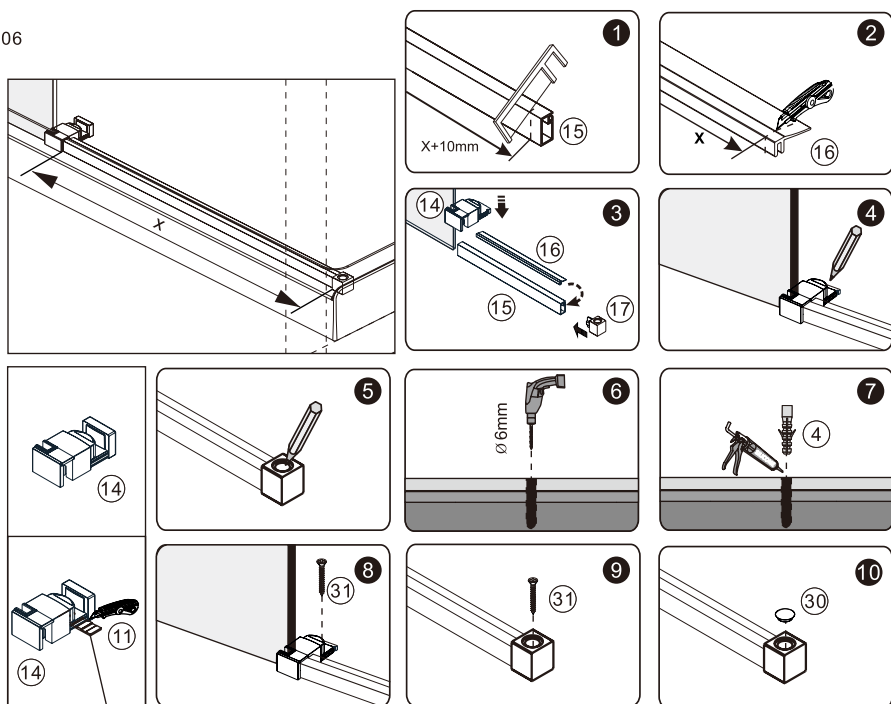

W przypadku, gdy poziom brodzika się obniża, aby zamontować prowadnik drzwi użyj klina pozycjonującego, aby zablokować go w pozycji poziomej.

A₀₇

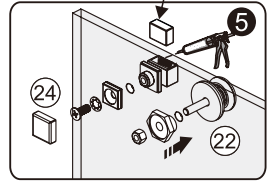
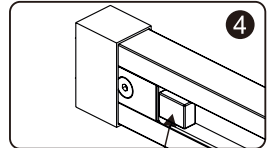
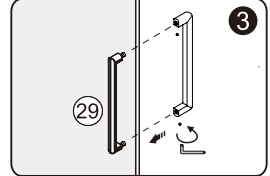
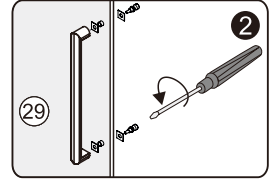
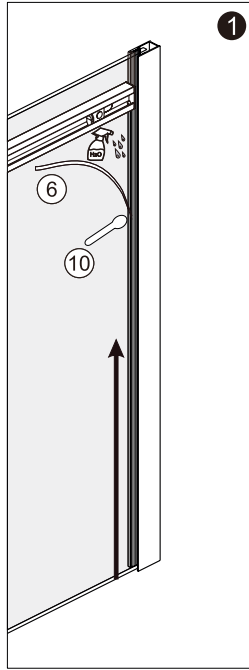
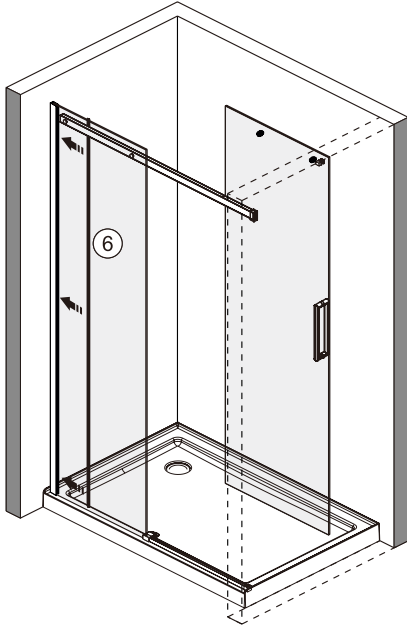

A₀₈

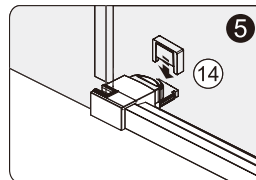
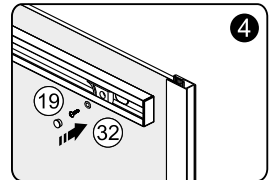
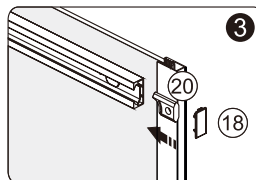
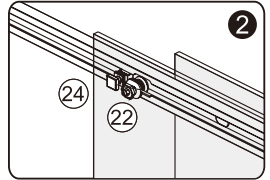
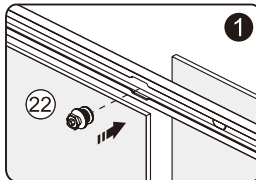
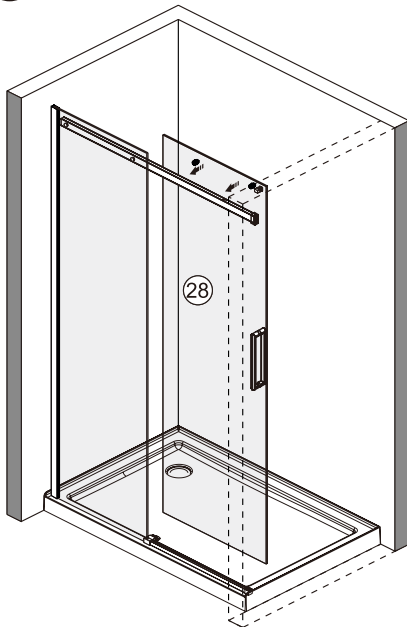

A 09

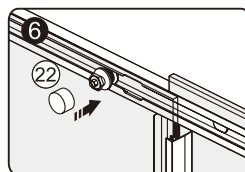
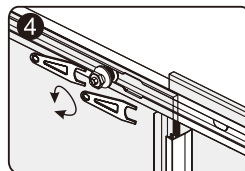
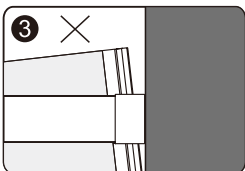
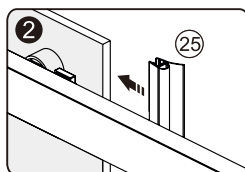
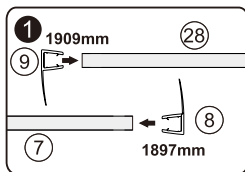
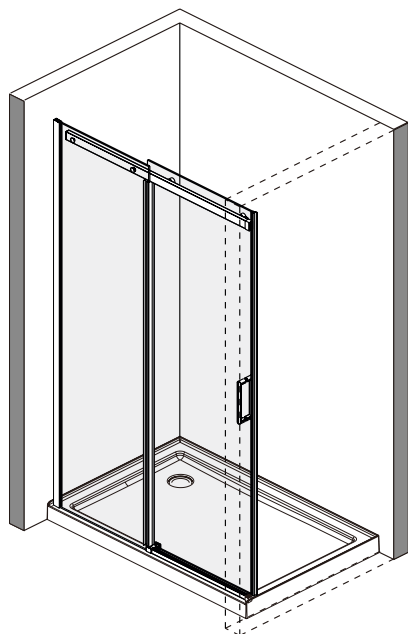

A 10

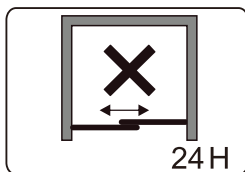
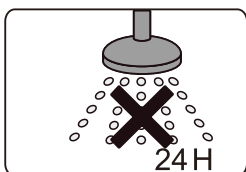
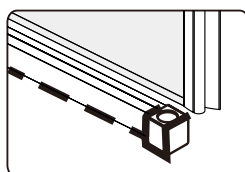
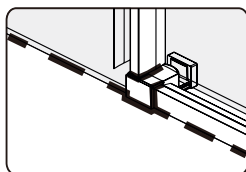
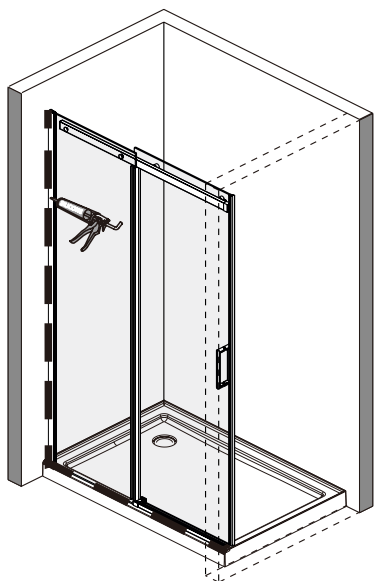

B 01 KAEX.2606

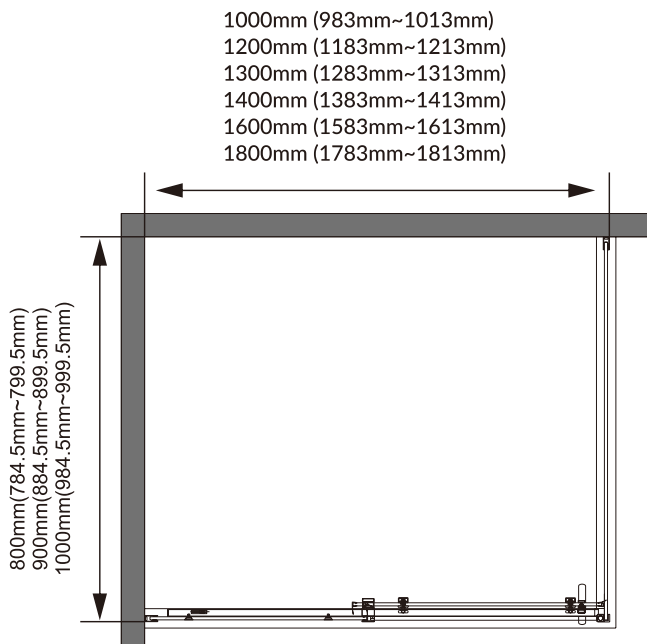

B 02

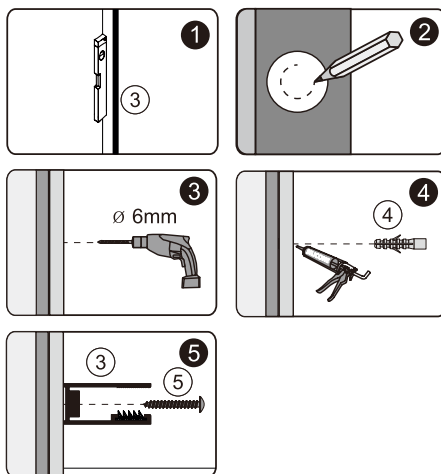
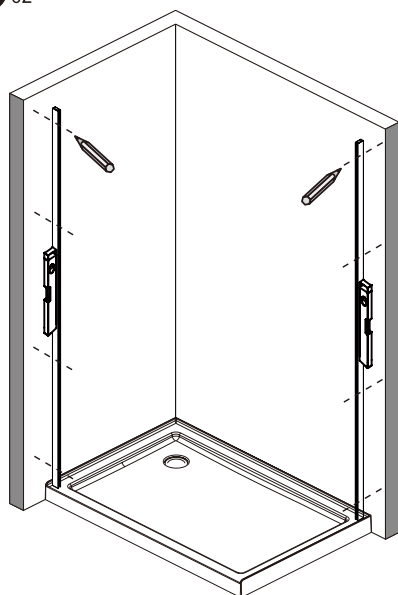

B 03

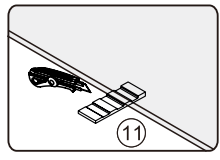
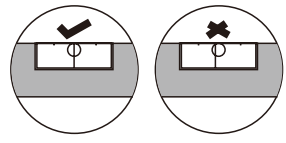
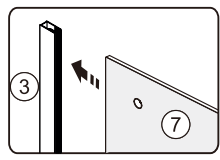
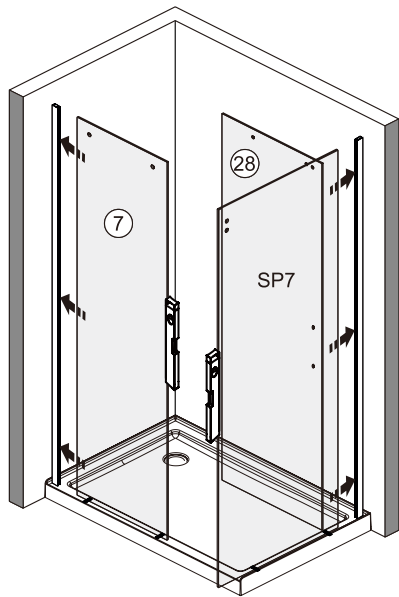

B 04

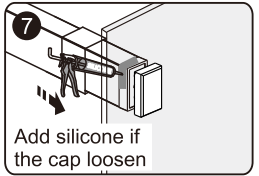
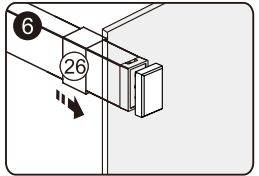
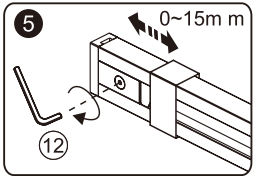
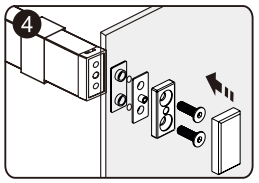
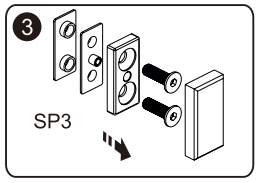
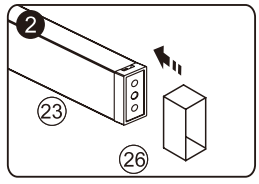
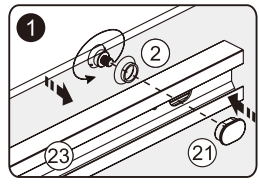
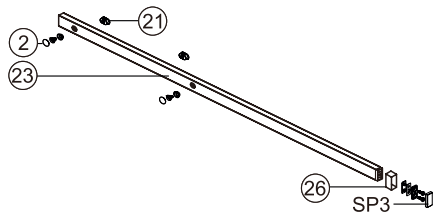
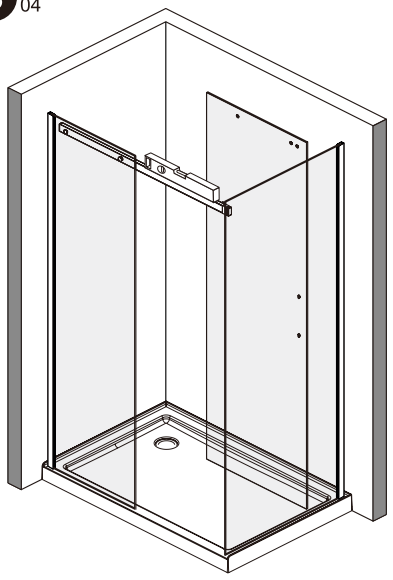

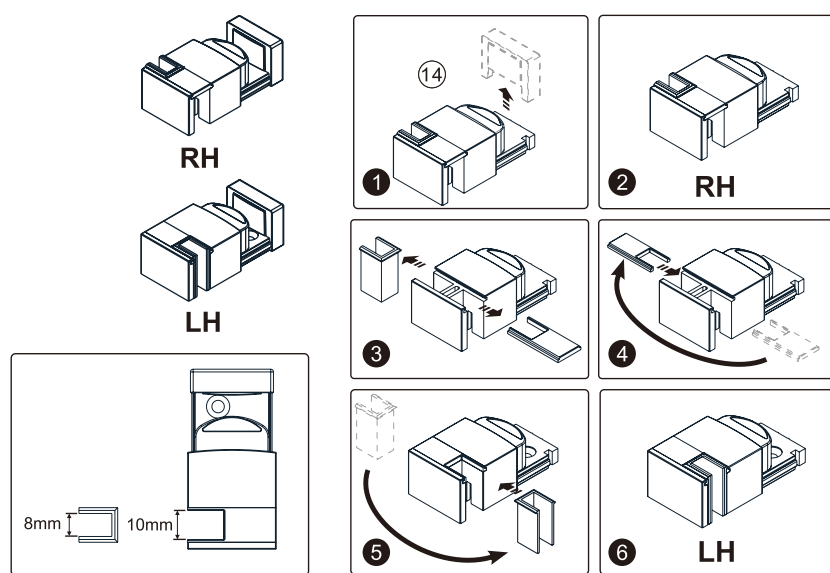
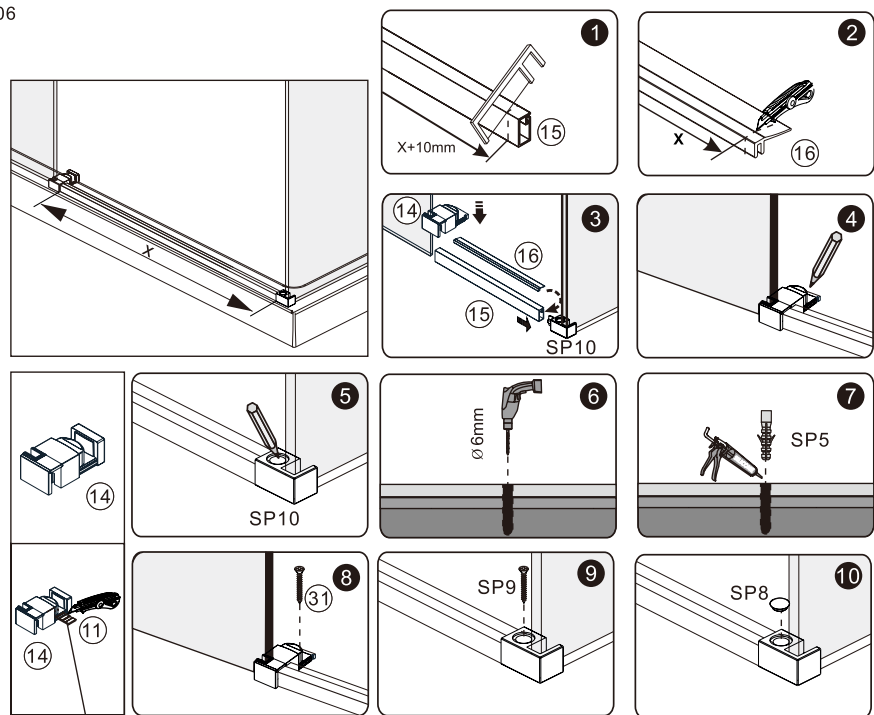
B 05**B** 06

W przypadku, gdy poziomy brodzik się obniży, aby zamontować prowadnik drzwi użyj klina pozycjonującego, aby zablokować go w pozycji poziomej.

B 07

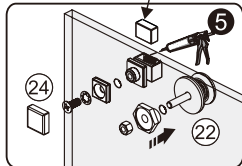
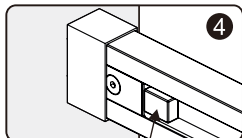
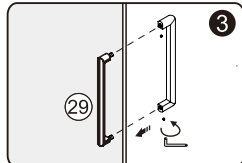
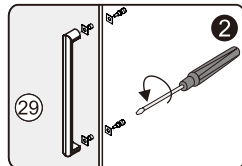
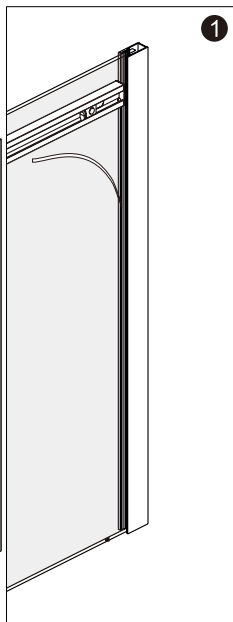
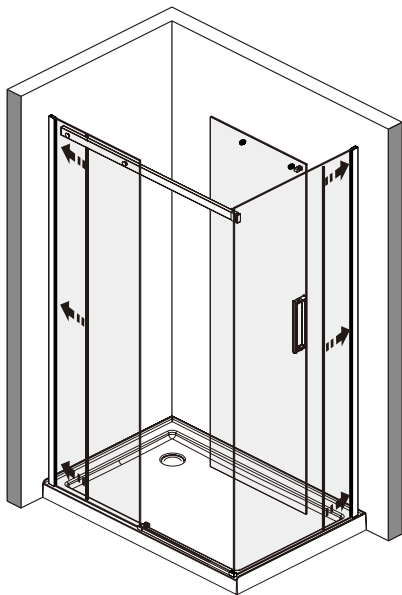

B 08

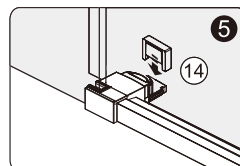
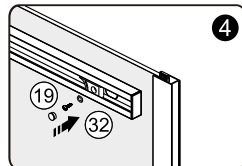
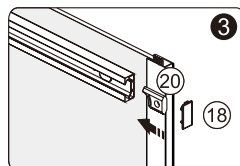
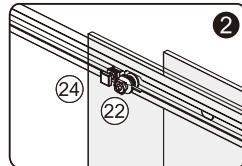
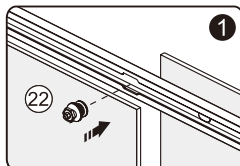
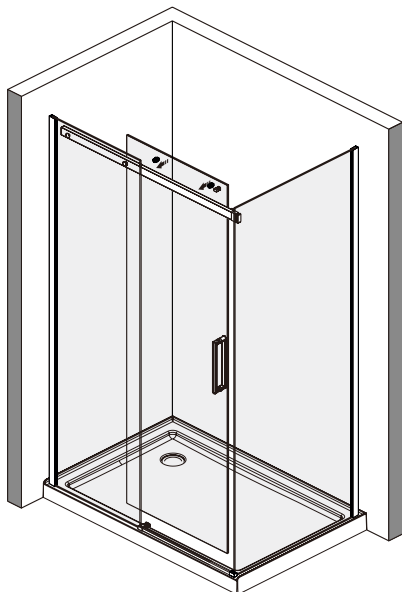

B 09

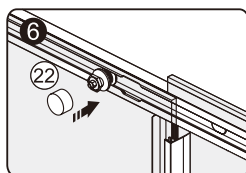
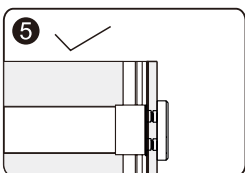
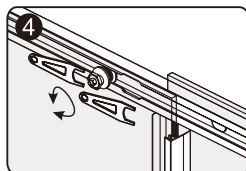
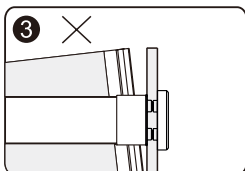
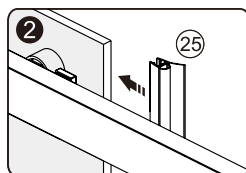
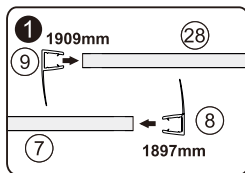
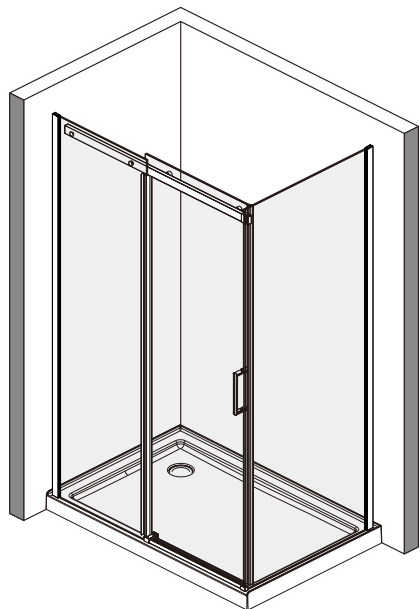

B 10

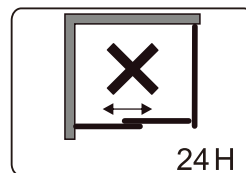
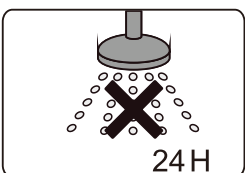
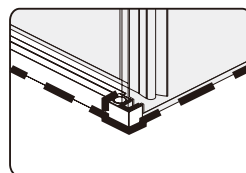
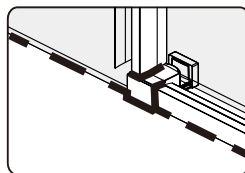
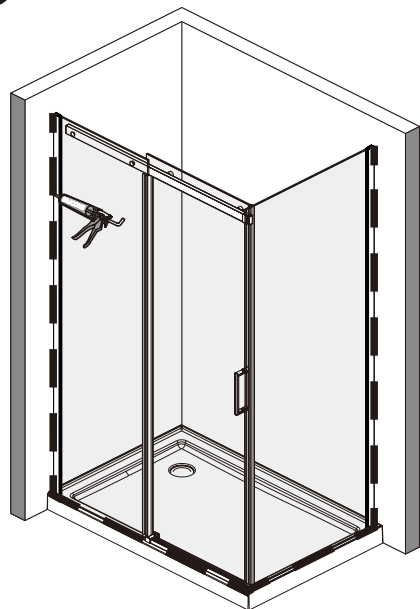

CZYSZCZENIE I KONSERWACJA

Aby utrzymać powierzchnię szkła kabiny w nienagannym stanie przez wiele miesięcy, warto zastosować się do poniższych wskazówek:

- Po każdej kąpieli należy spłukać szkło wodą a następnie ściągaczką do szyb lub miękką tkaniną usunąć wodę z powierzchni.
- Nie należy do czyszczenia kabiny używać środków zawierających kwasy, aceton, formaldehydy czy benzynę

GWARANCJA

Warunki gwarancji dostępne na stronie: <http://www.excellent.com.pl/gwarancja>

	5 LAT GWARANCJI	Kabiny Excellent – producent zapewnia 5 lat gwarancji. Nie dotyczy elementów podlegających naturalnemu zużyciu w trakcie eksploatacji takich jak: uszczelki oraz powłoka Clean Control.
---	---------------------------	--

GWARANCJA NIE OBEJMUJE:

- Uszkodzeń mechanicznych zawinionych przez sprzedawcę, instalatora lub użytkownika końcowego
- Wad i uszkodzeń powstałych na skutek niewłaściwego stosowania.
- Wad i uszkodzeń powstałych na skutek wadliwego zainstalowania wyrobu (niezgodnych z powyższą instrukcją oraz sztuką budowlaną).
- Przedwczesnego zużycia się elementów spowodowanym niewłaściwym montażem.
- Uszkodzeń powstałych na skutek osadzania się kamienia lub niewłaściwego czyszczenia.

Produkt spełnia wymagania normy: PN-EN 14428+A1:2018

CLEANING AND MAINTENANCE

To keep the glass surface of your shower enclosure in perfect condition for many months, follow these tips:

- After each bath, rinse the glass with water and then remove the water from the surface with a squeegee or a soft cloth.
- Do not use agents containing acids, acetone, formaldehyde or gasoline to clean the product.

WARRANTY

Warranty conditions available on website: <http://www.excellent.com.pl/gwarancja>

	5 YEAR WARRANTY	Shower enclosure Excellent - producer provides 5 year warranty. It does not apply to elements subject to natural wear during product shelf life, such as: gaskets and Clean Control surface.
---	---------------------------	---

THE WARRANTY DOES NOT COVER:

- Mechanical damage caused by the seller, installer or end user
- Defects and damage caused by improper use
- Defects and damages resulting from improper installation of the product (inconsistent with the above instructions and construction practice)
- Premature wear of components due to incorrect assembly
- Damage caused by limescale build-up or improper cleaning

The product meets the requirements of the standard: PN-EN 14428 + A1: 2018

ČIŠTĚNÍ A ÚDRŽBA

Abyste udrželi skleněný povrch vašeho stánku v perfektním stavu po mnoho měsíců, dodržujte tyto tipy:

- Po každé koupeli opláchněte sklenici vodou a poté vodu z povrchu odstraňte stěrkou na okna nebo měkkým hadříkem.
- K čištění kabiny nepoužívejte prostředky obsahující kyseliny, aceton, formaldehyd nebo benzin.

ZÁRUKA

Záruční podmínky jsou k dispozici na: <http://www.excellent.com.pl/gwarancja>

	5 LET ZÁRUKY	Sprchové kabiny Excellent – výrobce poskytuje záruku 5 let. Neplatí pro díly podléhající přirozenému opotřebení při používání, jako jsou: těsnění a nátěr Clean Control.
---	------------------------	--

ZÁRUKA SE NEVZTAHUJE NA:

- Mechanické poškození způsobené prodejcem, montérem nebo koncovým uživatelem
- Vady a poškození způsobené nesprávným používáním
- Vady a poškození vyplývající z nesprávné instalace výrobku (v rozporu s výše uvedenými pokyny a konstrukční praxí)
- Předčasné opotřebení součástí v důsledku nesprávné montáže
- Poškození způsobené usazováním vodního kamene nebo nesprávným čištěním

Výrobek splňuje požadavky normy: PN-EN 14428 + A1: 2018

EXCELLENT

Excellent SA
32-003 Podłęże 662

Tel.: 12 657 18 87
e-mail: lazienki@excellent.com.pl

www.excellent.com.pl