

**KTSU 042P** (800x2000)  
**KTSU 041P** (900x2000)  
**KTSU 043P** (1000x2000)

**KTSU N42P** (800x2000)  
**KTSU N41P** (900x2000)  
**KTSU N43P** (1000x2000)

**PL** Instrukcja montażu  
**EN** Assembly instructions  
**DE** Montageanleitung  
**LV** Instalēšanas instrukcijas  
**RU** Инструкция по установке  
**UK** Інструкція по установці  
**RO** Instrucțiunile de instalare  
**HR** Upute za montažu

**FR** Instructions d'installation  
**NO** Installasjonsinstruksjoner  
**LT** Instaliavimo instrukcijas  
**FI** Asennusohjeet  
**SK** Pokyny na inštaláciu  
**HU** Telepítési utasítások  
**CS** Pokyny k instalaci  
**SV** Monteringsanvisning

**PL** Przed rozpoczęciem montażu należy sprawdzić czy towar nie posiada wad, oraz czy jest kompletny. Firma Deante sp. z o.o. nie ponosi odpowiedzialności za widoczne defekty produktu po jego montażu. Przed montażem szyb należy wyczyścić okolice ich mocowań przy użyciu podstawowych środków czystości przeznaczonych do czyszczenia szkła. Do montażu zaleca się używania tylko i wyłącznie sylikonu sanitarnego. Po rozpakowaniu kabiny chroni szyby przed uderzeniami podczas odkładania ich na podłoże (np. odkładając je na karton). Unikaj uderzeń o krawędzi szyb bądź ich rogi.

**EN** Before starting the assembly, it is necessary to check whether or not a cubicle has defects and is complete. The company: Deante sp. z o.o. does not bear responsibility for noticeable defects of the product after its assembly. Before installation of panes, it is required to clean out places of their fixing with the use of basic cleaners intended for cleaning glass. For assembly it is advisable to use only sanitary silicone. After unpacking the cubicle, protect panes from hits while putting them on the surface (e.g. by putting them on a cardboard). Avoid hits on panes' edges or their corners.

**DE** Vor der Montage soll überprüft werden, ob die Ware mangelfrei und vollständig ist. Die Firma Deante sp. z o.o. haftet nicht für sichtbare Produktdefekte nach seiner Montage. Vor der Glasscheibenmontage sind die Stellen um die Befestigungen herum mit normalem Glasreiniger sauber zu machen. Es wird empfohlen, für die Montage nur Sanitär-Silikon zu verwenden. Nach der Auspackung der Kabine sollen die Glasscheiben vor Schlägen infolge des Ablegens auf den Boden (z.B. wenn die auf den Karton abgelegt werden) geschützt werden. Man soll vermeiden, gegen die Scheibenkanten bzw. -ecken zu schlagen.

**LT** Pirms sākt uzstādīšanu, pārbaudiet, vai precei nav defektu, un, vai tā ir nokomplektēta. Uzņēmums Deante sp. z o.o. neatbild par redzamiem produkta defektiem pēc montāžas. Pirms caurspīdīgo sienīņu uzstādīšanas, tās jānotīra ar stiprinājuma vietām, izmantotaj mazgāšanas līdzekļus, kas paredzēti stikla tīrīšanai. Uzstādīšanai ieteicams izmantot tikai un vienīgi sanitāro silikonu. Pēc kabīnes detaļu uzsaiņošanas sargāt caurspīdīgās sienīņas pret triecienu to novietošanas laikā uz pamatnes (piem. novietojiet tās uz kartona kastes). Izvairīties no caurspīdīgo sienīņu malu vai stūru sasišanas.

**RU** Перед началом монтажа следует убедиться в наличии всех элементов и в отсутствии дефектов. Фирма Deante sp. z o.o. не несет ответственности за видимые дефекты изделия после его монтажа. Перед началом монтажа стекол следует очистить область их установки, при использовании основных моющих средств, предназначенных для чистки стекла. Для монтажа рекомендуется использовать только санитарный силикон. После распаковки кабины следует защитить стекла от ударов при откладывании их на пол (например, класть их на картон). Избегайте ударов о края стекол или об их углы.

**UK** Перед початком збірки і установки перевірити чи товар не має дефектів і чи повністю укомплектований Фірма Deante sp. z o.o. (Данте Антчак Повне товариство) не несе відповідальність за дефекти виробу, які проявилися після його монтажу. Перед монтажем скляних стінок необхідно вичистити зони їх кріплення за допомогою миючих засобів, призначених для миття скла. Для монтажу рекомендується використовувати тільки і виключно санітарний силікон. Після розпакування кабінки оберігати скляні елементи від ударів під час відкладання (напр. відкладення їх на картон). Уникайте ударів краями скла або їх кутами.

**RO** Înainte de începerea montajului trebuie verificat dacă marfa nu posedă defecte și dacă este completă. Firma Deante sp. z o.o. nu este responsabilă pentru defecte vizibile ale produsului după montajul acestuia. Înainte de montajul geamurilor trebuie curățate locurile de montare cu folosirea produselor de curățenie de bază, destinate curățării sticlei. Pentru montaj se recomandă folosirea exclusivă a siliconului sanitar.

După despachetarea cabinei, protejați geamurile împotriva impactului în timpul așezării lor pe podea (plasându-le de exemplu pe carton). Evitați loviriile marginilor sau colțurilor acestora.

**HR** Prije početka montaže provjeriti da li je proizvod kompletn i da li nema ikakvih nedostataka. Tvrtka Deante sp. z o.o. ne snosi odgovornost za vidljive nedostatke na proizvodu nakon montaže istog. Prije montaže stakala potrebno je pažljivo očistiti mjesto na kojima će stakla biti montirana, pomoću uobičajenih sredstava za čišćenje stakla. Za izvođenje montaže preporučuje se isključivo sanitarni silikon. Nakon raspakiranja kabine potrebno je zaštititi stakla od oštećenje npr. prilikom stavljanja ih na pod – treba prethodno zaštititi pod kartonom. Treba izbjegavati udaranja u ivice ili uglove stakala.

**FR** Avant de commencer l'installation vérifiez si la marchandise est sans défauts et si elle est complète. La société Firma Deante sp. z o.o. se décline de toute responsabilité des défauts visibles apparus après l'installation. Avant l'installation nettoyez les surfaces de fixation avec des produits de nettoyage pour le verre. Pour l'installation utilisez uniquement le silicone sanitaire. Après le déballage de la cabine protégez les vitrages contre le choc lorsqu'elle est posée sur le sol (posez les vitrages sur un carton). Évitez les chocs pouvant affecter les vitrages ou leurs bord.

**NO** Før oppstart av monteringen, sjekk om varen ikke har feil og om settet er komplett. Selskapet Deante sp. z o.o. tar ikke ansvar for synlige produktfeil etter at produktet er montert. Før monteringen av glass skal festepunkter rengjøres ved hjelp av vanlige vaske-midler til rengjøring av glass. Til monteringen bør kun sanitært silikone brukes. Etter utpakkning av kabinettet, beskytt glasset mot slag, mens du legger det på gulvet (legg glass på kartong). Unngå slag på glasskanten eller glasshjørnet.

**LV** Prieš pradėdami montuoti kabiną, pirmiausia reikia patikrinti ar prekė neturi trūkumų, ir ar yra pilnai sukomplektuota. Firma Deante sp. z o.o. nepiima atsakomybės už akivaizdžius gaminio defektus po jo montavimo. Prieš atliekant montavimo darbus būtina išvalyti tvirtinamąsias vietas naudojant valymo priemones skirtas stiklams valyti. Montavimui rekomenduojama naudoti veini tikai sanitarinį silikoną. Išėmus kabiną iš pakuotės būtina saugoti kabinos stiklus nuo sutrenkimų ypač dėdant juos ant grindinio (pav. patiesiant po jais kartono lakštus). Būtina stengtis išvengti stiklų kraštų ar kampų sutrenkimų.

**FI** Ennen asennuksen aloittamista tulee tarkistaa, onko tavaraa vikoja sekä onko tavara täydellinen. Deante sp. z o.o. ei ole vastuussa tuotteen olevista näkyvistä vioista sen asennuksen jälkeen. Ennen suihkukaabin lasien asennusta niiden tulee kiinnityskohdan alueet puhdistaa käyttäen lasin puhdistukseen tarkoitettuja peruspuhdistusaineita. Asennukseen suositellaan käytettäväksi vain ja ainoastaan saniteettisilikonia. Suihkukaabin pakkauksesta purkamisen jälkeen lasit tulee suojata iskulla vastaan niiden alustalle asentamisen aikana (esim. suojaamalla ne pahvilla). Vältä iskuja levyjen reunoihin tai kulmiin.

**SK** Pred montážou skontrolujte, či tovar nie poškodený, a či je kompletný. Firma Deante sp. z o.o. nenesie žiadnu zodpovednosť za vady viditeľné na produkte po jeho namontovaní. Skla v blízkosti miest ich upevnenia pred montážou vyčistite pomocou základných čistiacich prostriedkov určených na čistenie skla. Na montáž používajte výlučne sanitárny silikón. Po rozbalení kabíny chráňte sklá pred nárazmi, ku ktorým môže dochádzať pri ich odkladaní (napr. pri ich odkladaní na kartóne). Vyhnite sa nárazom do hrán alebo rohov skiel.

**HU** Összeszerelés előtt ellenőrizze, hogy az áru minden eleme sérülésmentes legyen és megtalálható a csomagolásban. A Deante sp. z o.o. nem vállalja a felelősséget az összeszerelés után észlelt sérülésekért. Az üveg szerelése előtt tisztítsa meg az üvegszerelés helyeit normál üveg tisztító szerrel. A szerelésnél csak és kizárólag szaniter szilikont használjon. Miután kicsoma golta a kabinát átrakodás közben védje az üveget az esetleges ütésektől (pl. kartonpapírra rakás közben). Vigyázzon szélekre és a sarkokra.

**CS** Před zahájením montáže zkontrolujte zboží, jestli nemá vady a jestli je kompletní. Firma Deante sp. z o.o. nenese zodpovědnost za viditelné defekty produktu po jeho montáži. Před montáží skel vyčistěte okolí jejich připevnění za použití základních čistících prostředků určených k čištění skla. K montáži se doporučuje používat jen a výhradně sanitární silikon. Po rozbalení sprchového koutu chráňte skla před úderem během jejich odkládání na podklad (např. je odložte na kartón). Vyvarujte se úderů o hrany skel nebo jejich rohy.

**SV** Innan monteringen påbörjas ska man kontrollera att varan inte är defekt och att den är komplett. Deante sp. z o.o. ansvarar inte för synliga fel på produkten efter att den har monterats. Innan monteringen av rutorna ska man rengöra området kring deras fästen med vanligt glasrengöringsmedel. Det rekommenderas att man enbart använder sanitetssilikon vid monteringen. Efter att kabinen packats upp ska rutorna skyddas mot stötar då de läggs ner på underlaget (de kan t.ex. läggas på kartong). Undvik att stöta rutornas kanter eller hörn.

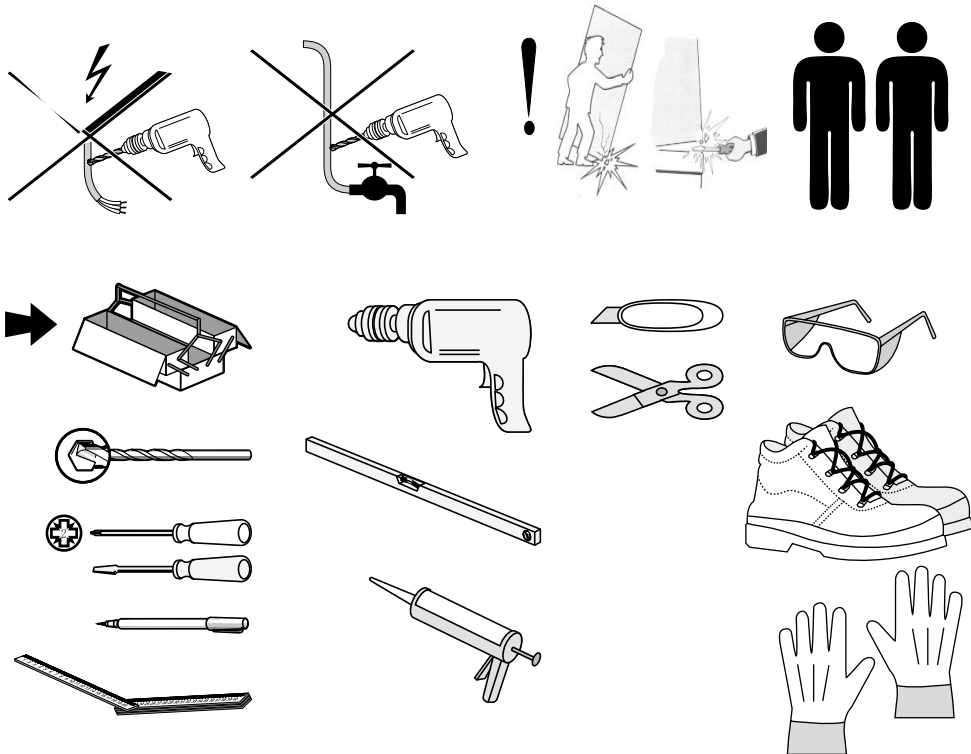

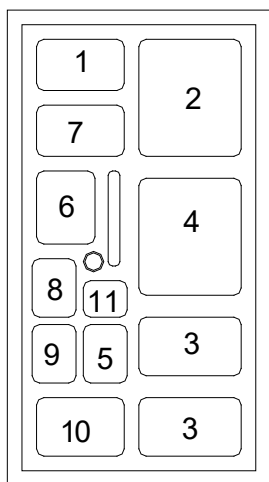







1	x1		6	x4	
1	x1		7	x2	
2	x1		8	x3	
2	x1		9	x3	
3	x1		10	x1	
3	x1		10	x1	
3	x1		11	x3	
4	x1			x1	
5	x4				





A	x1	
B	x1	
G	x4	 ST4X30
J	x4	
K	x4	 

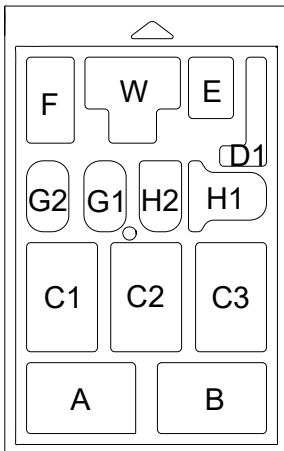
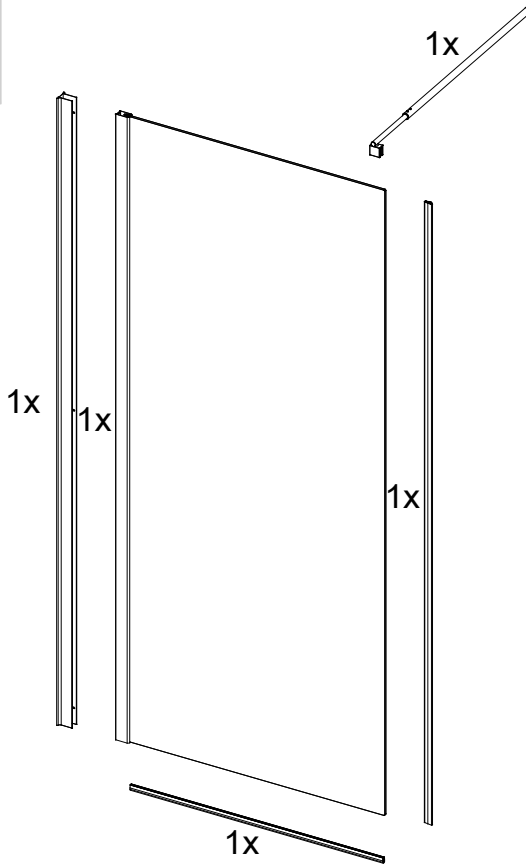

A	x2		G1	x1	
H1	x2		H2	x1	
		ST4X30			
B	x4		C2	x1	
		ST4X30			
B	x6		G2	x3	
					ST3.5X9.5
E	x1		C1	x3	
F	x1		W	x1	
C3	x1		D1	x1	
					Ø1.6 mm
C3	x1		D1	x1	



X2 P7-P19



X2 P45-P57



+



P20-P31



+



P32-P44

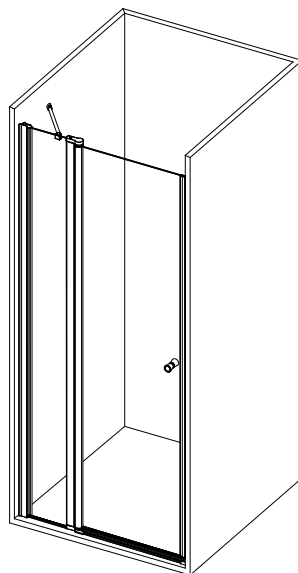



P58-P71

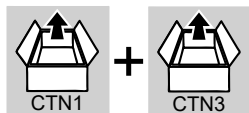
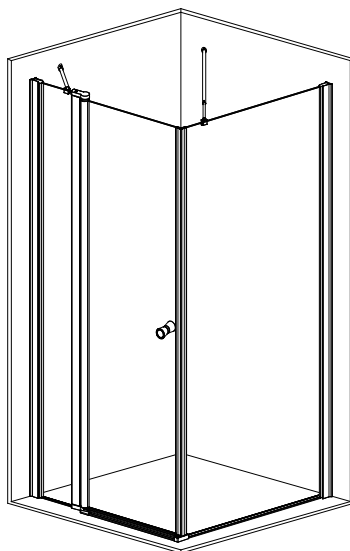

P72-P86





W:

800 787mm-800mm

900 887mm-900mm

1000 987mm-1000mm

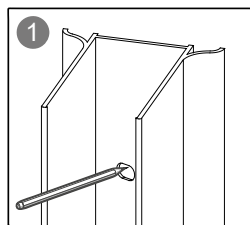
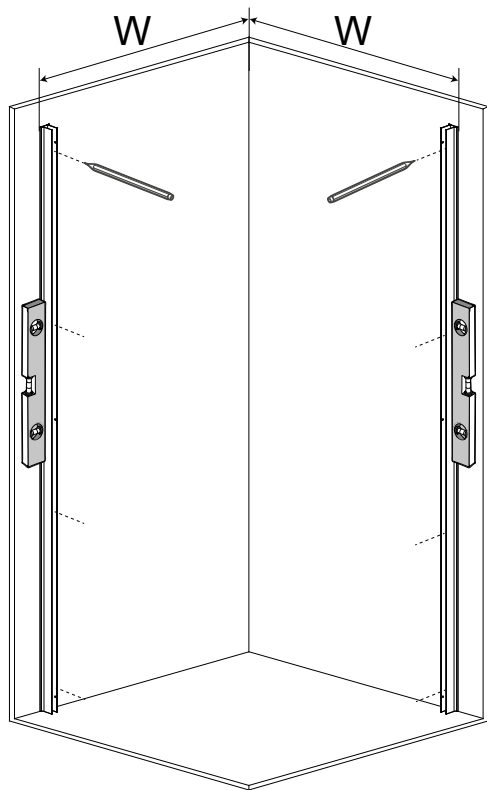

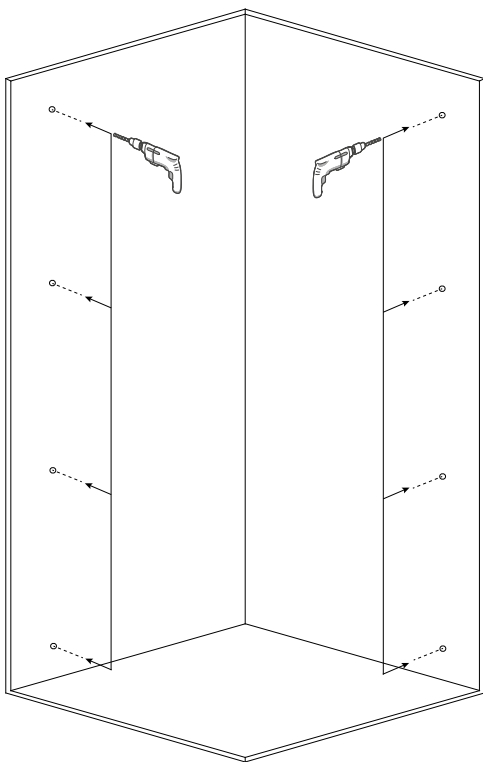





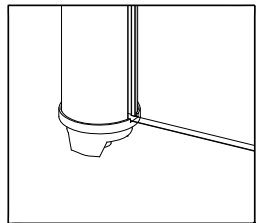
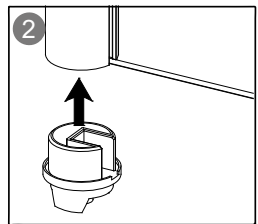
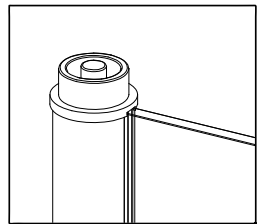
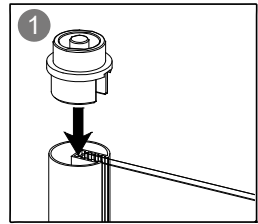
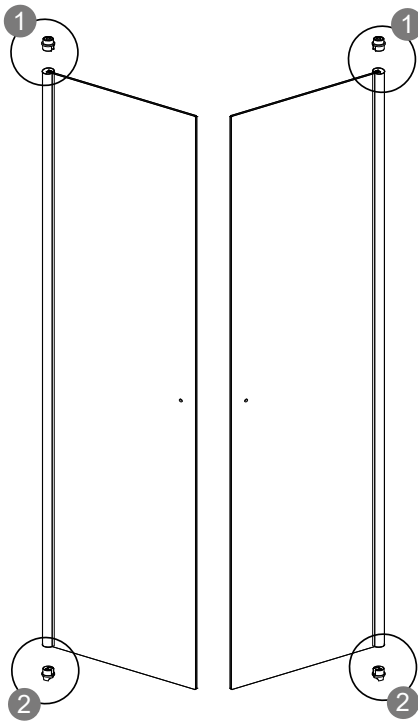

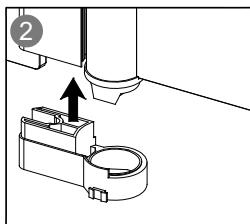
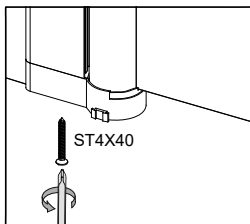
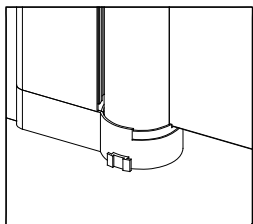
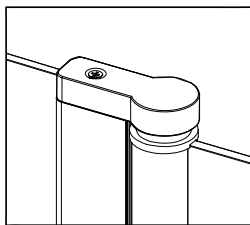
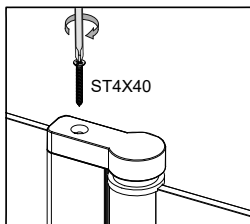
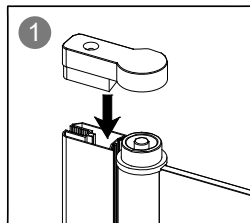
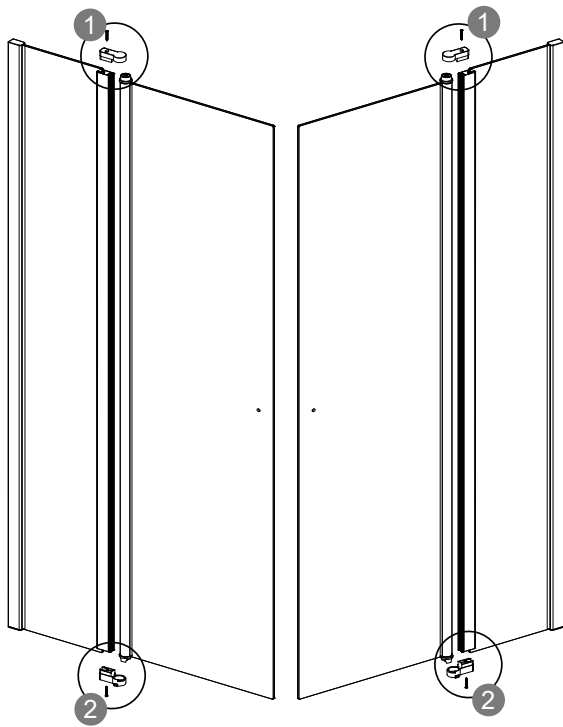

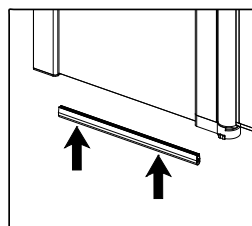
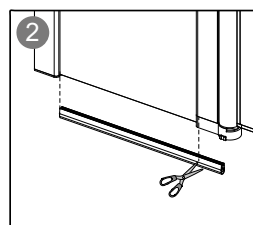
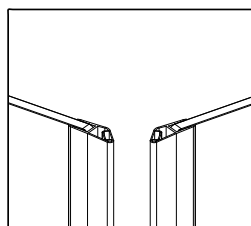

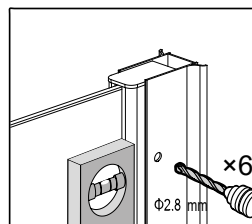
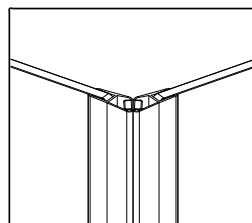
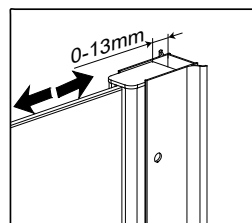
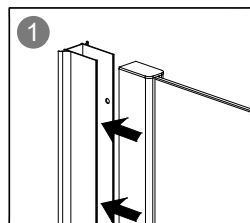
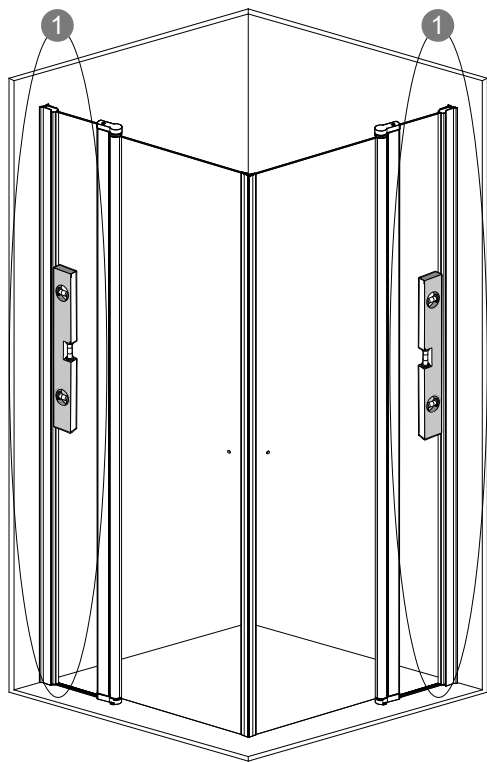

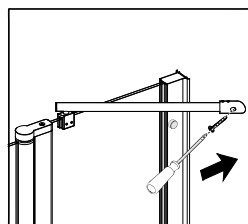
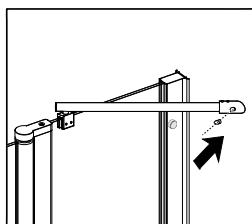
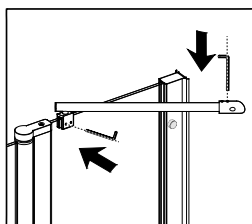
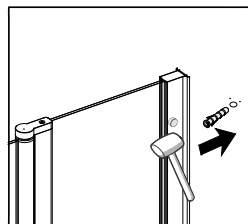
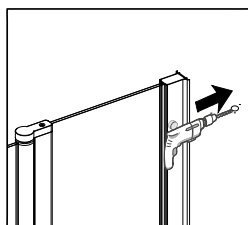
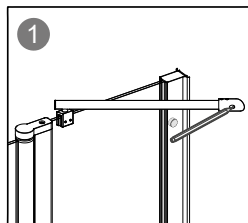
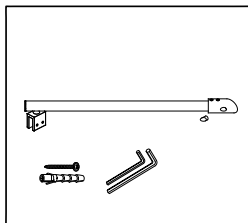
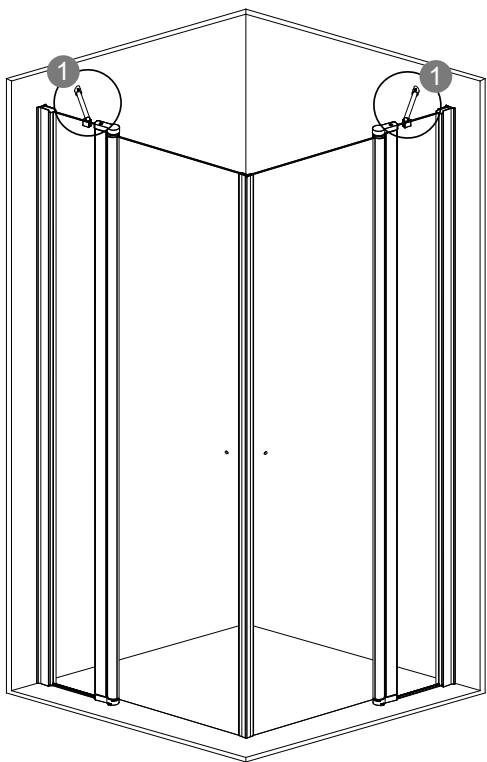

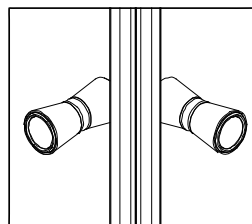
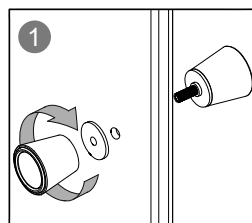
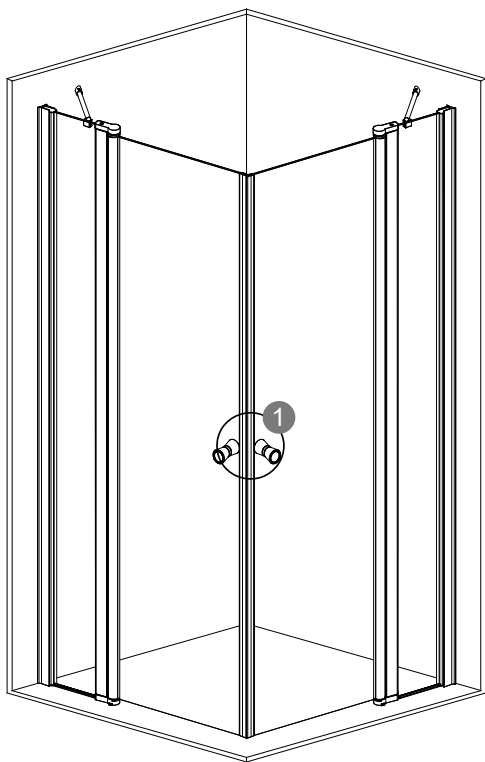



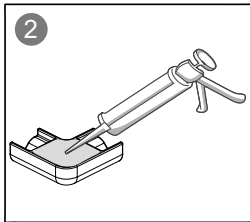
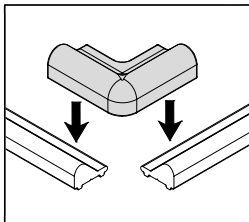
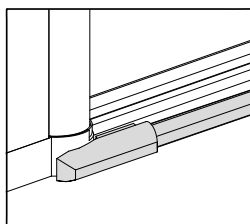
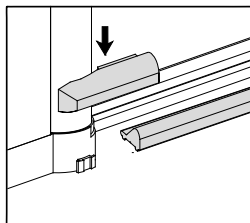
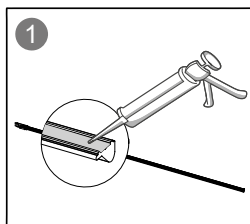
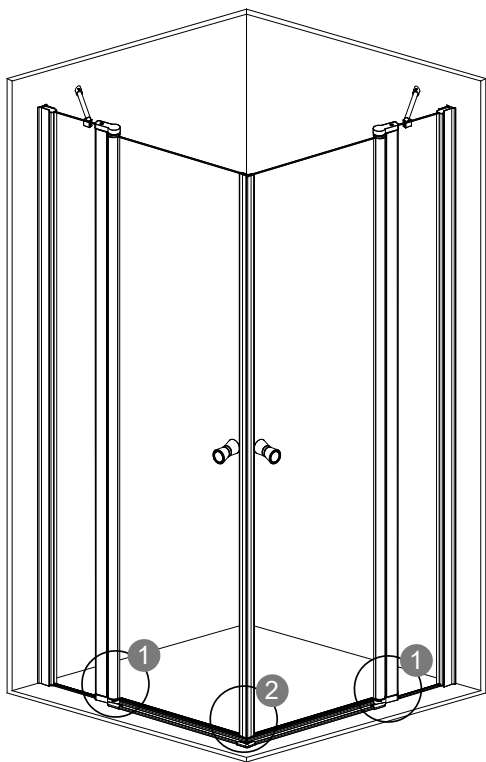





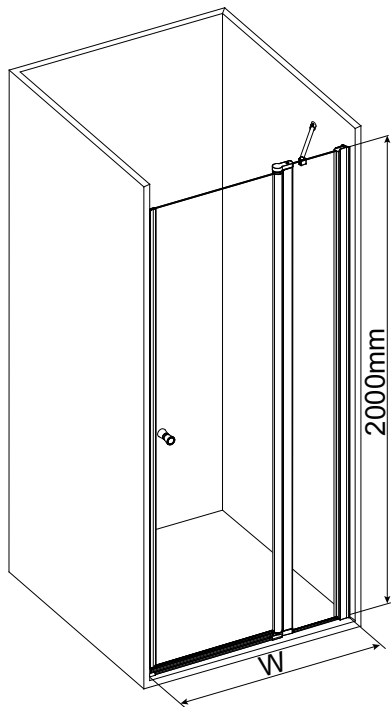

W:	
800	775mm-800mm
900	875mm-900mm
1000	975mm-1000mm

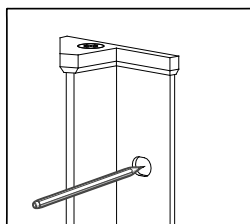
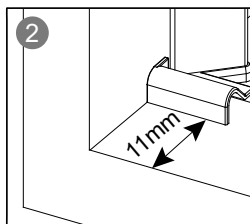
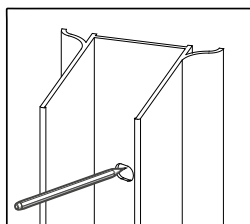
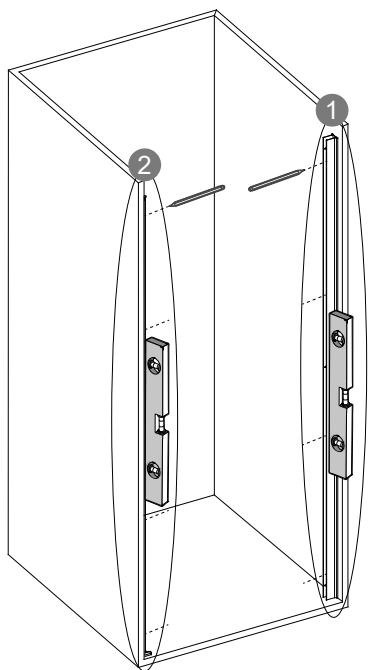

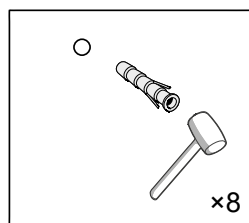
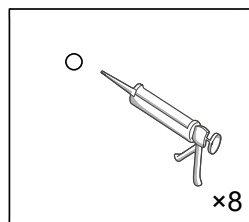
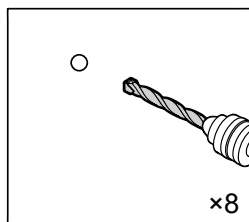

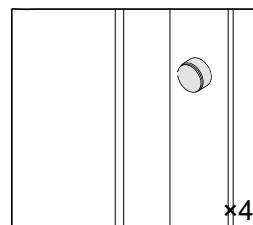
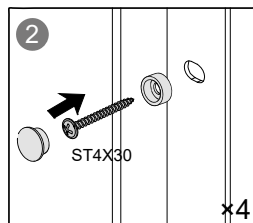
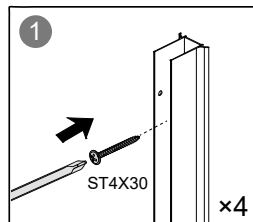
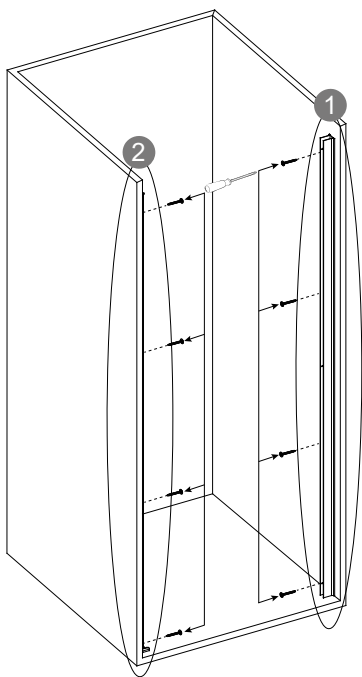

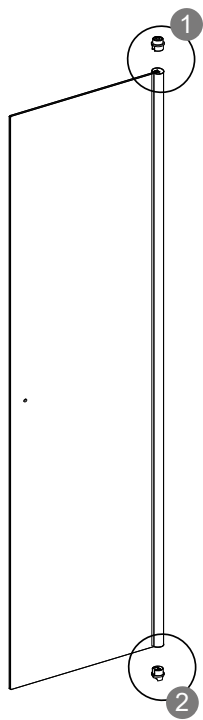



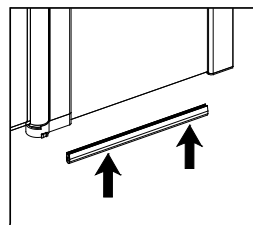
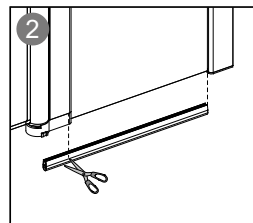
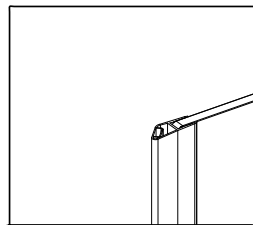
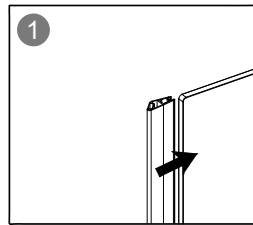
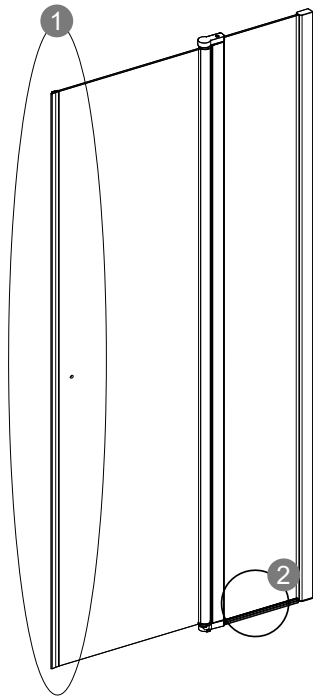



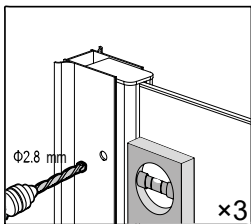
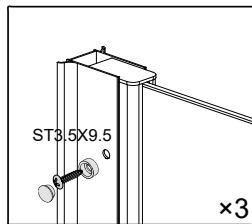
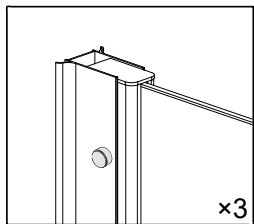
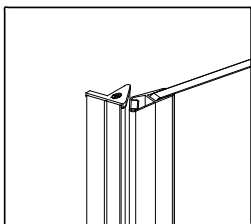
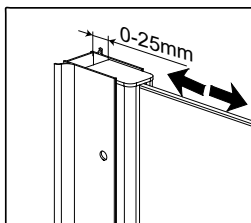

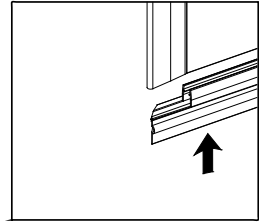
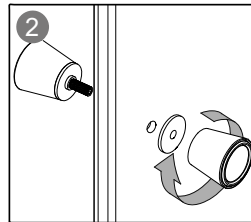
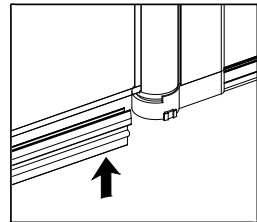
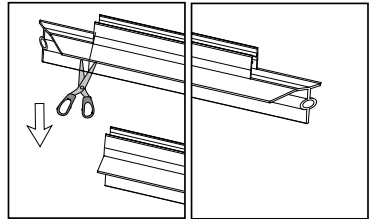
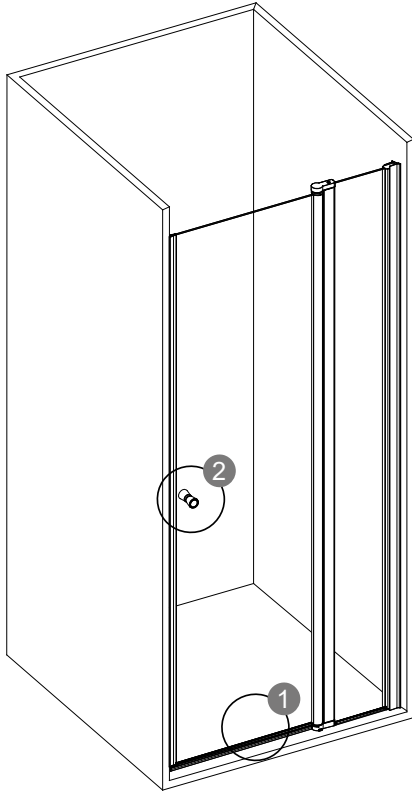

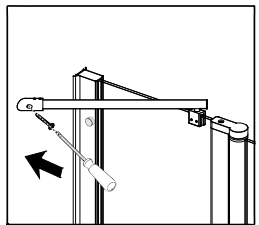
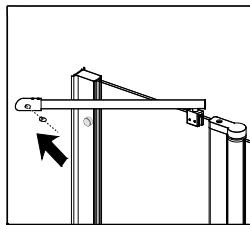
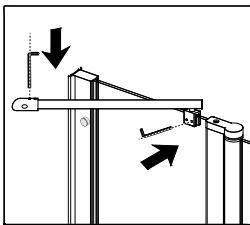
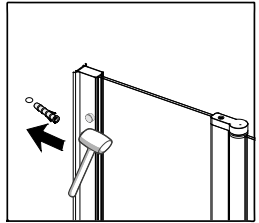
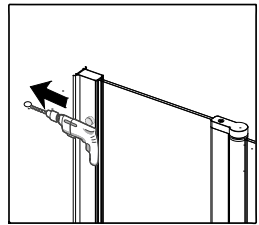
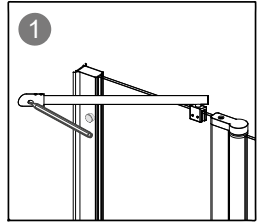

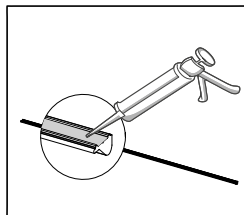

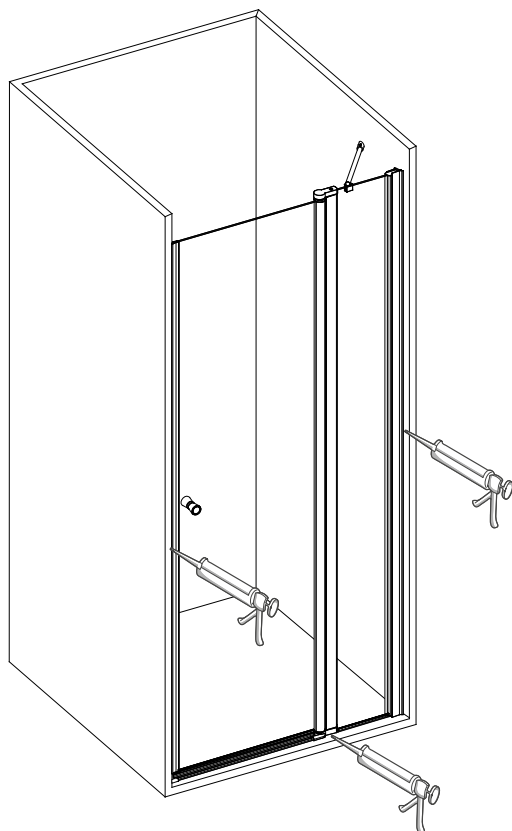



W:  
800 775mm-800mm  
900 875mm-900mm  
1000 975mm-1000mm

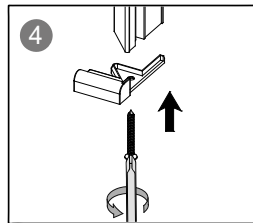
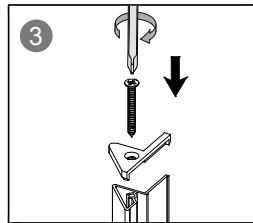
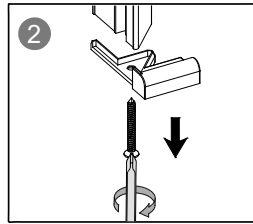
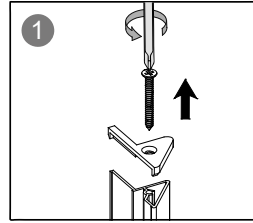
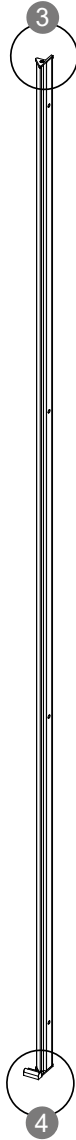
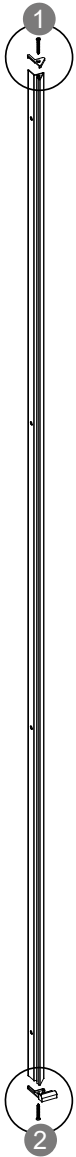

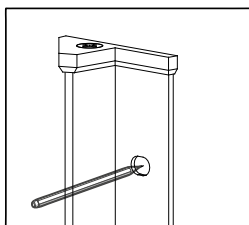
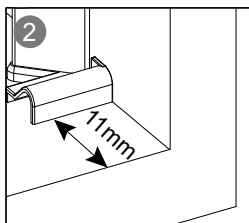
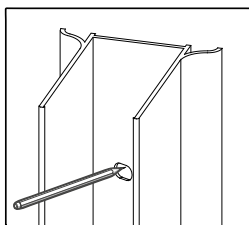
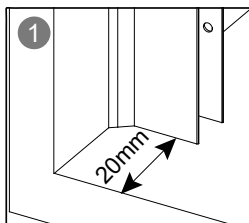
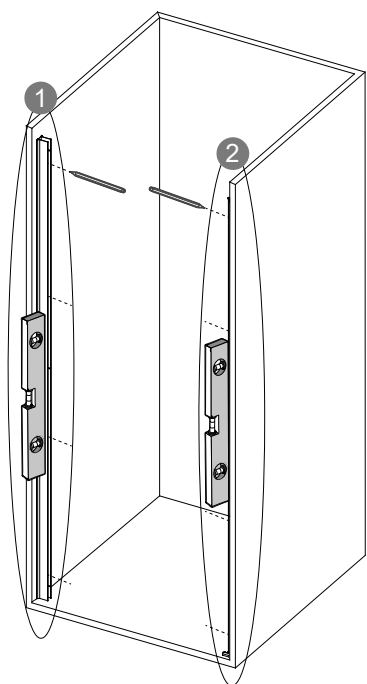



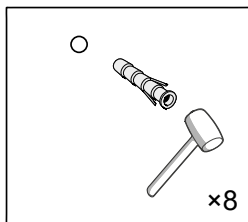
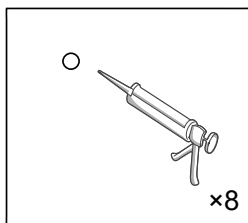
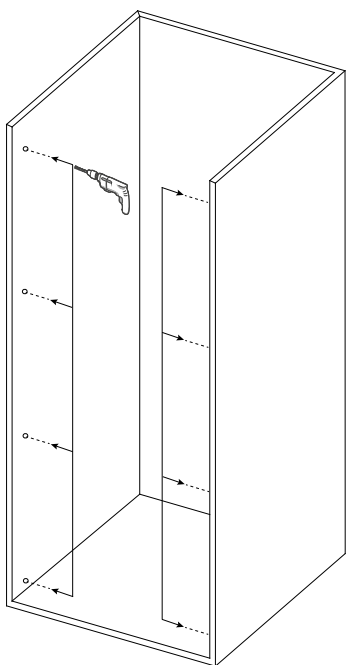

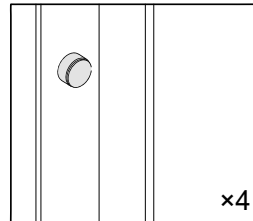
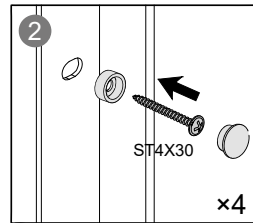
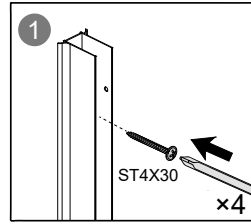
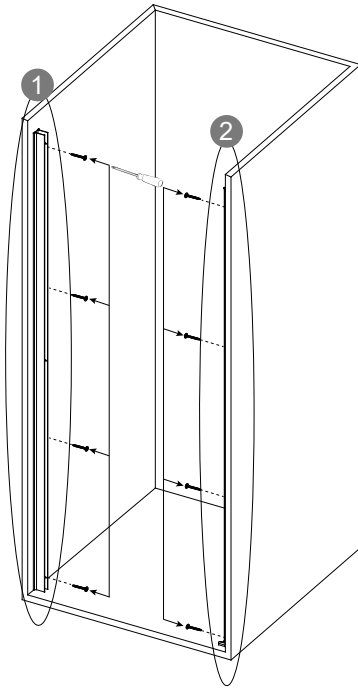

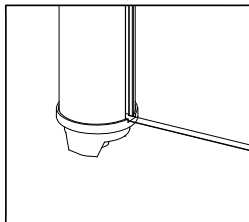
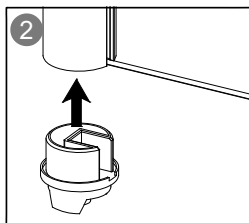
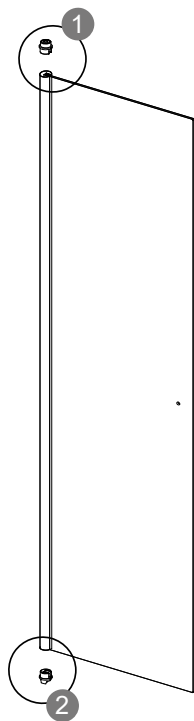

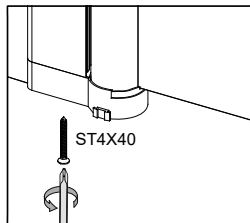
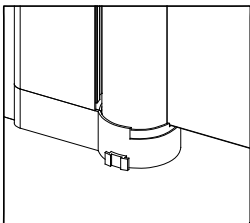

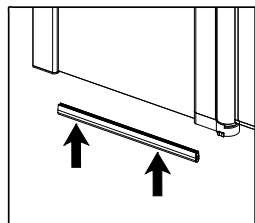
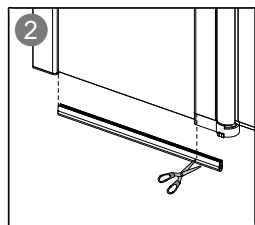
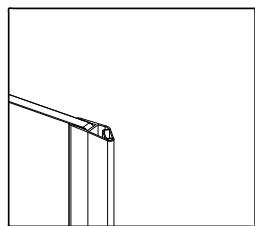
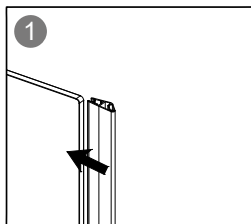

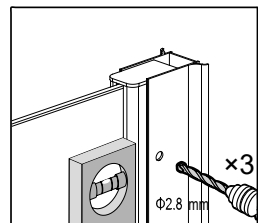
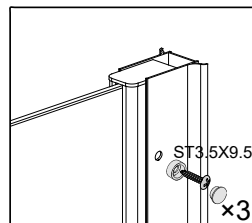
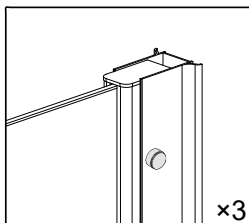
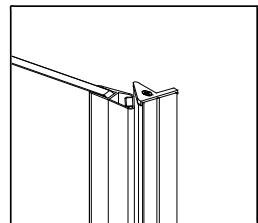
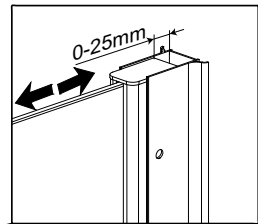
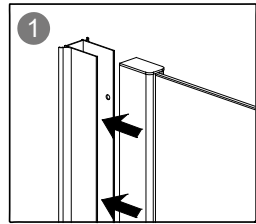
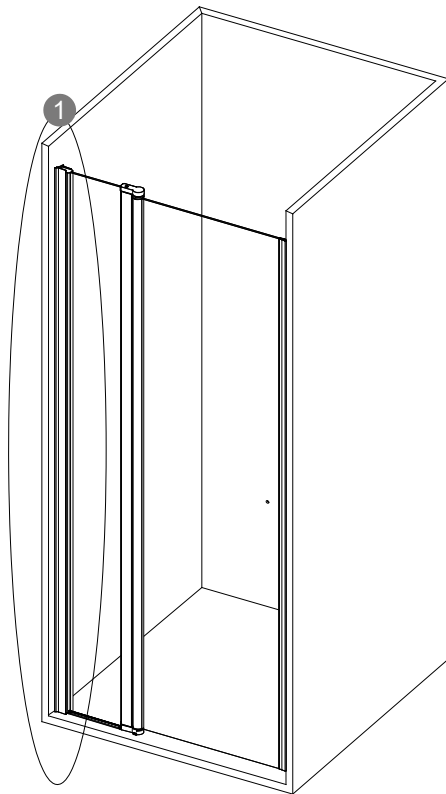

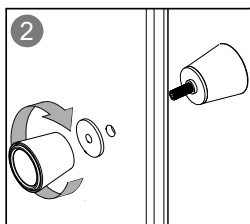

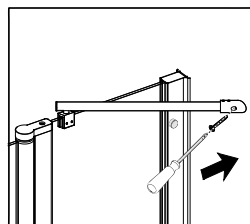
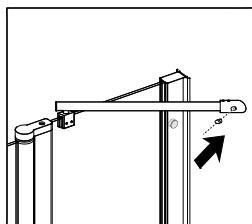
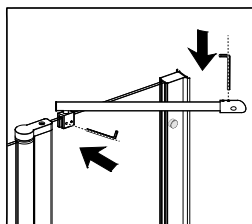
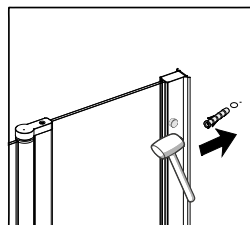
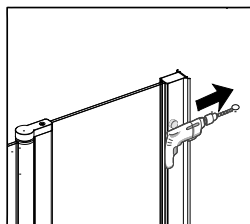
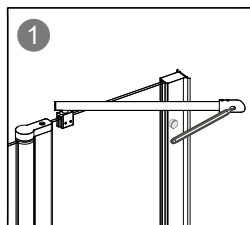
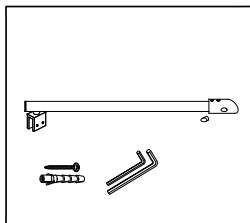
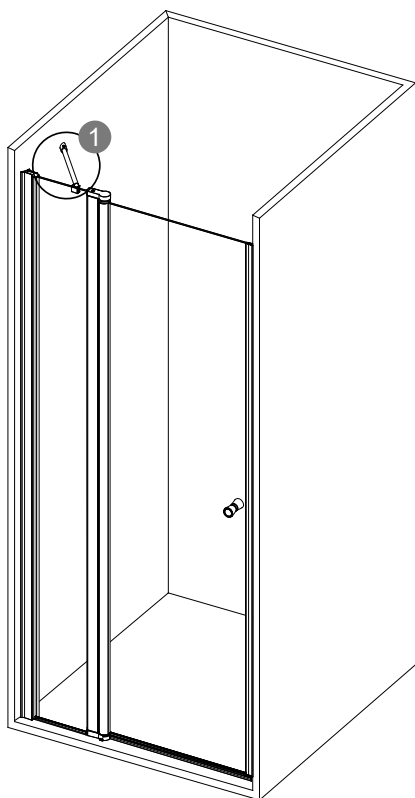



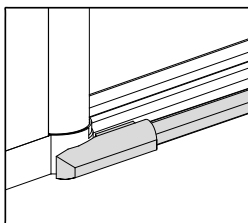
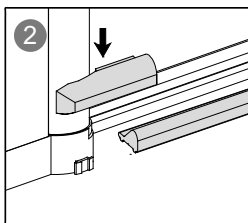
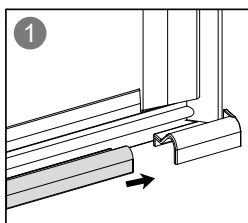
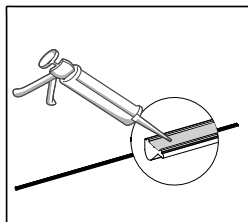

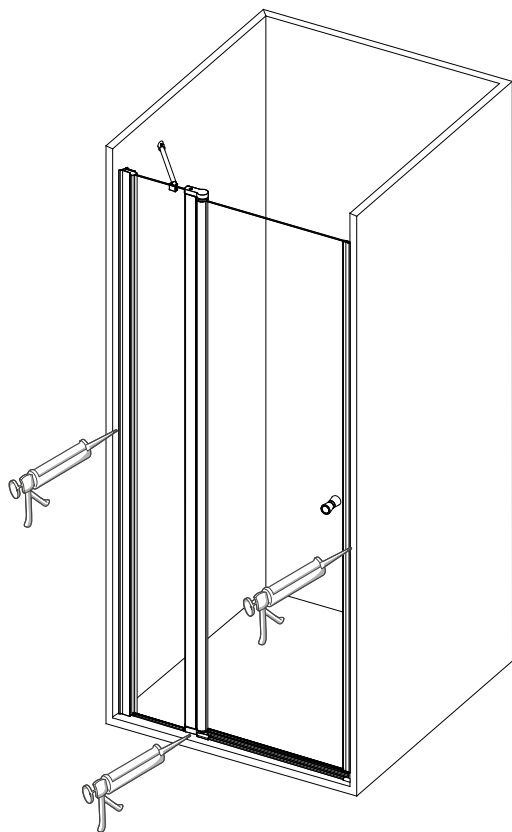



W:

800 765mm-785mm

900 865mm-885mm

1000 965mm-985mm



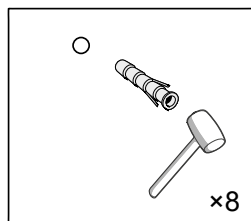
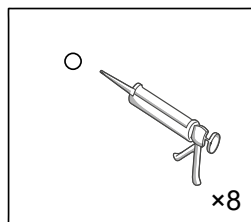
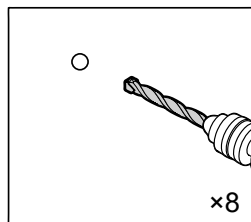
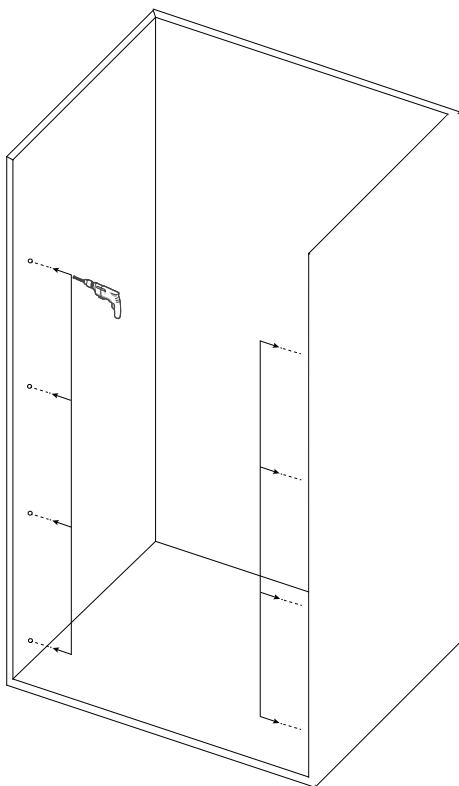

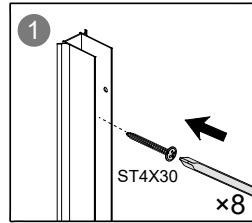
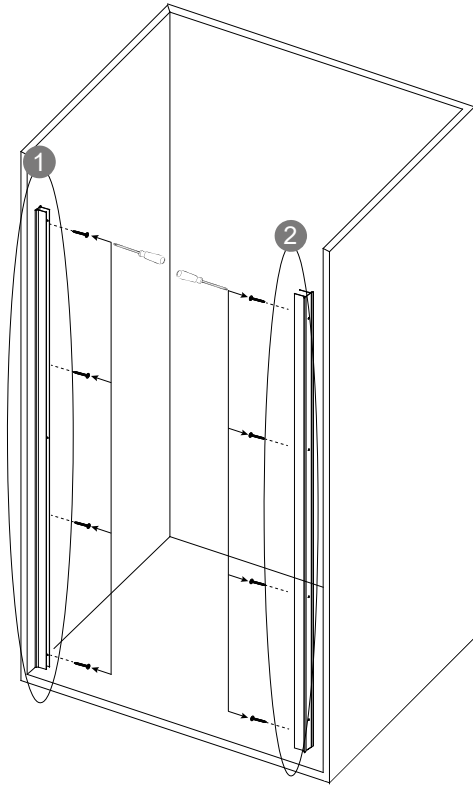

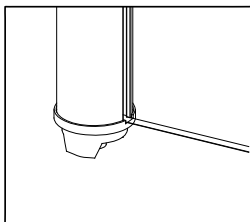
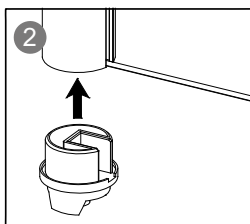
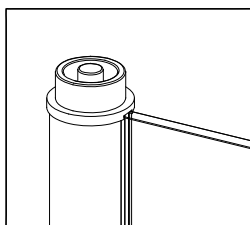
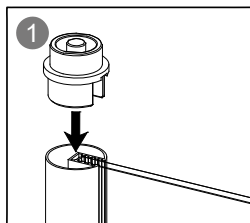
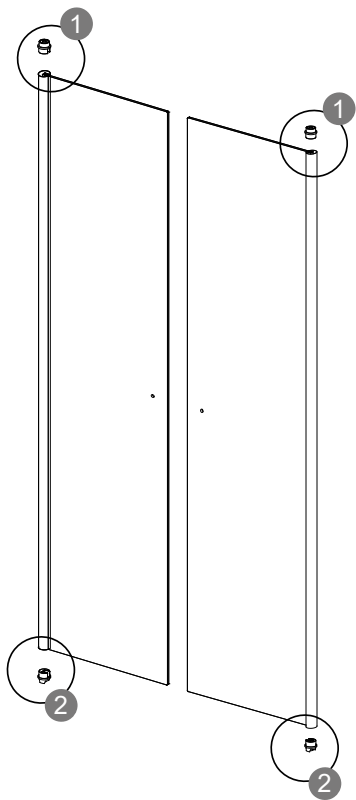

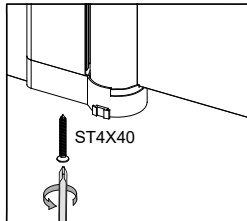



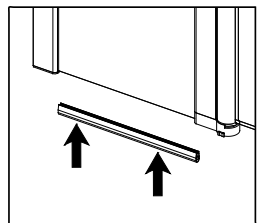
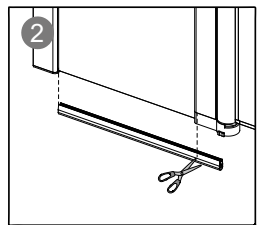
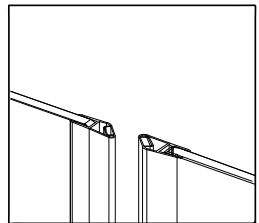
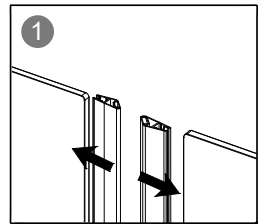
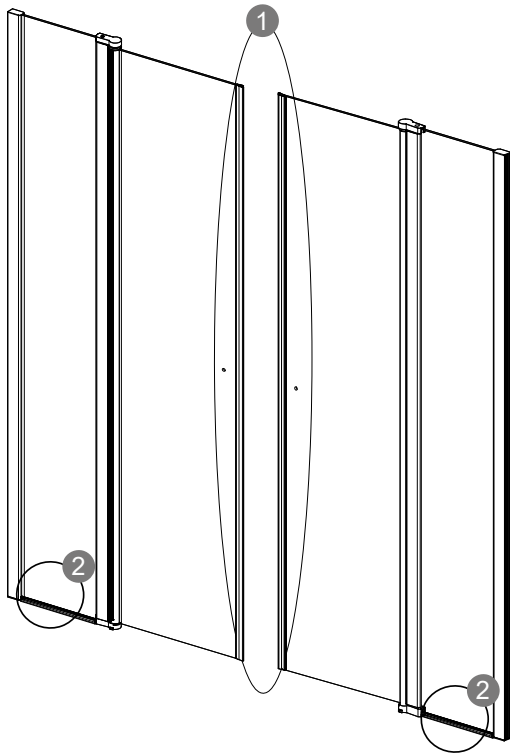

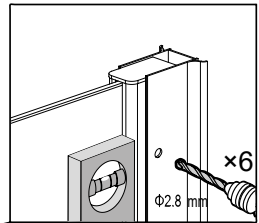
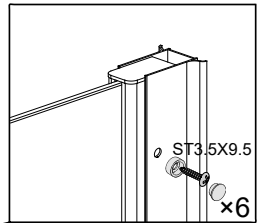
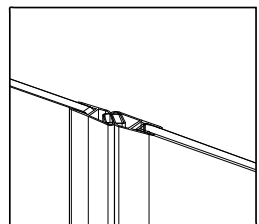
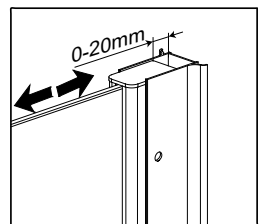

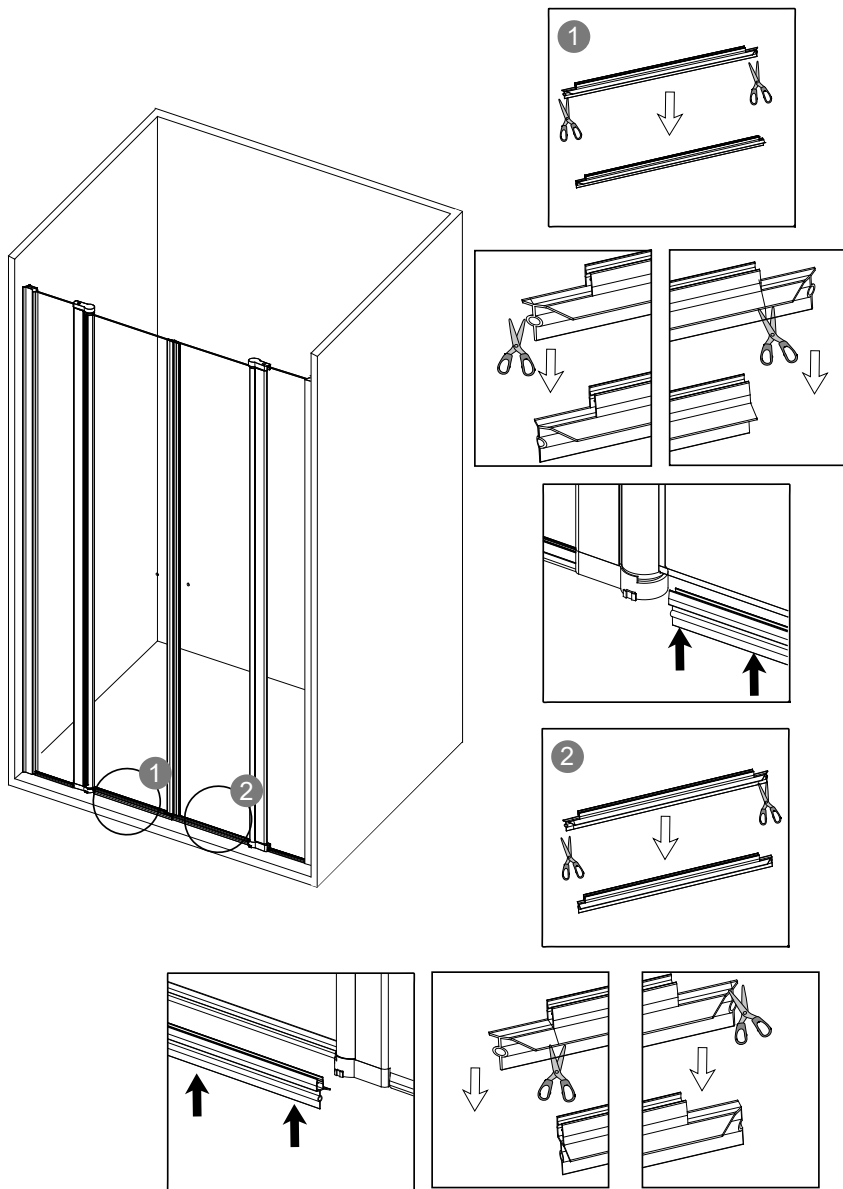

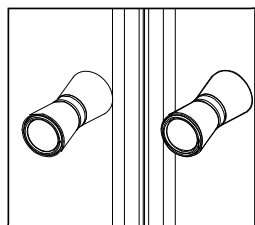
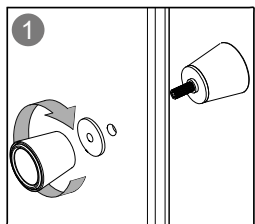
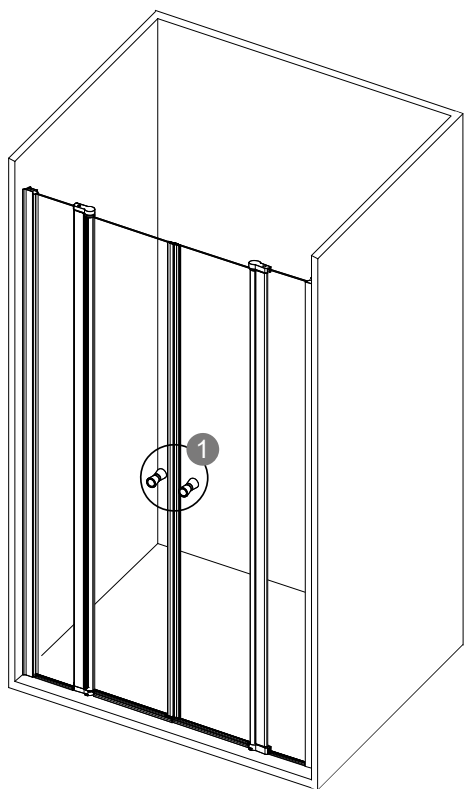

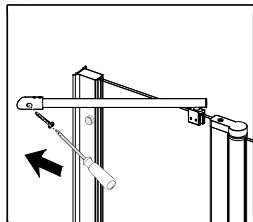
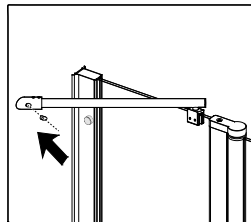
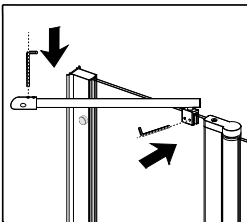
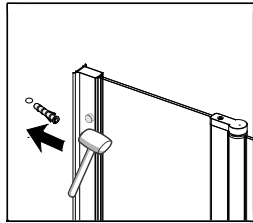
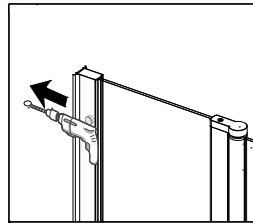
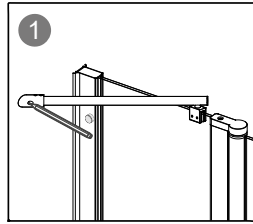
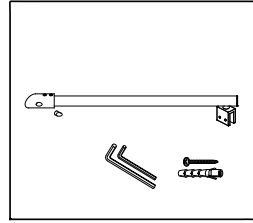
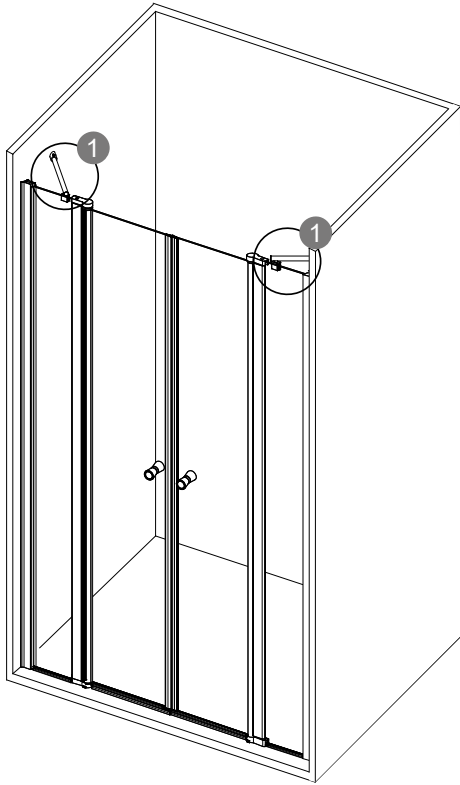

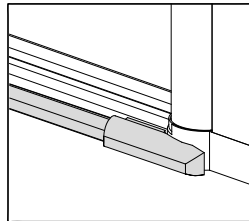
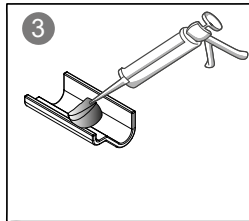
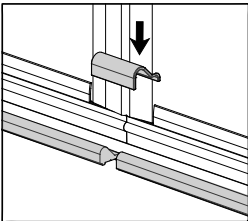
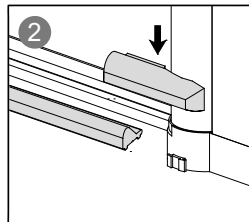
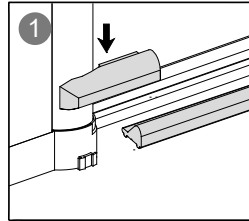
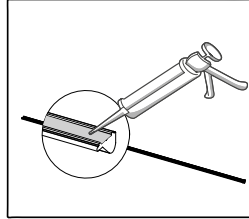





W1		W2	
800	787mm-800mm	300	280mm-300mm
900	887mm-900mm	400	380mm-400mm
1000	987mm-1000mm	700	680mm-700mm
		800	780mm-800mm
		900	880mm-900mm
		1000	980mm-1000mm
		1100	1080mm-1100mm
		1200	1180mm-1200mm
		1400	1380mm-1400mm





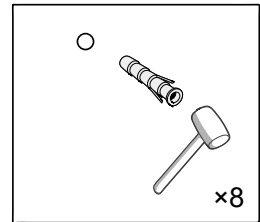
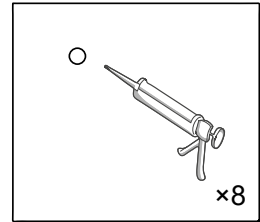
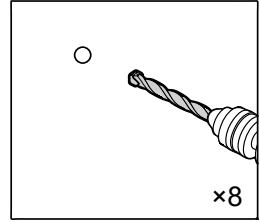

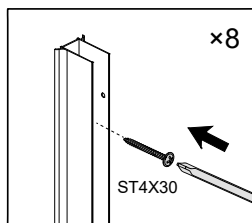
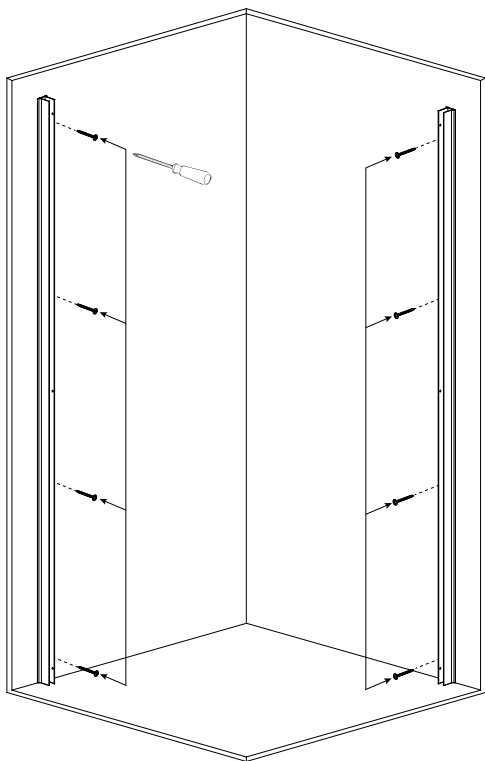



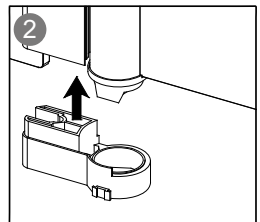
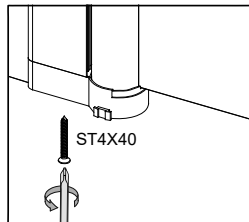
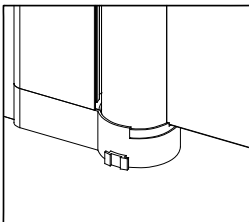
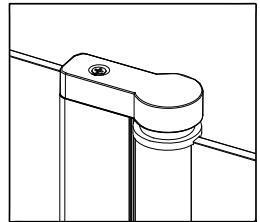
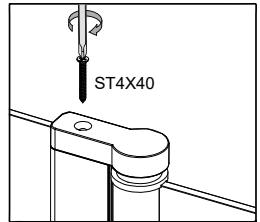
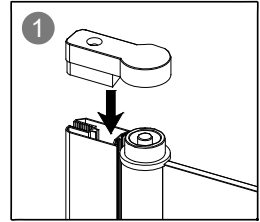

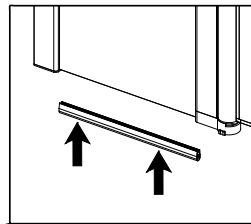
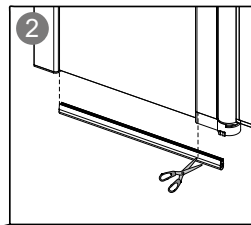
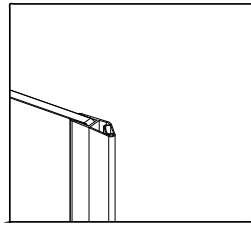

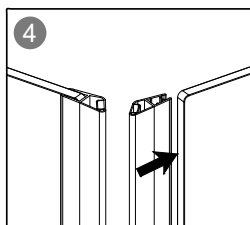
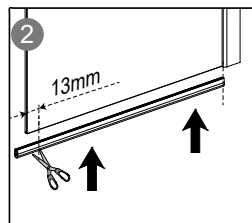

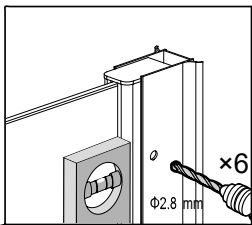
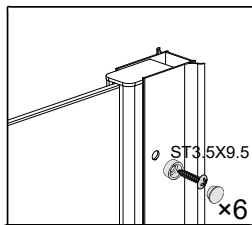
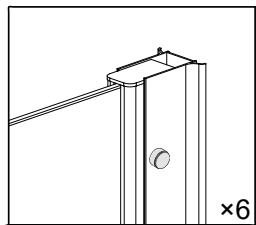
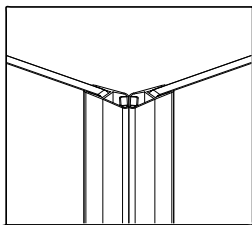
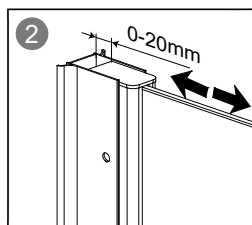
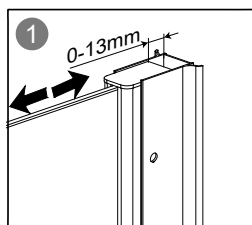
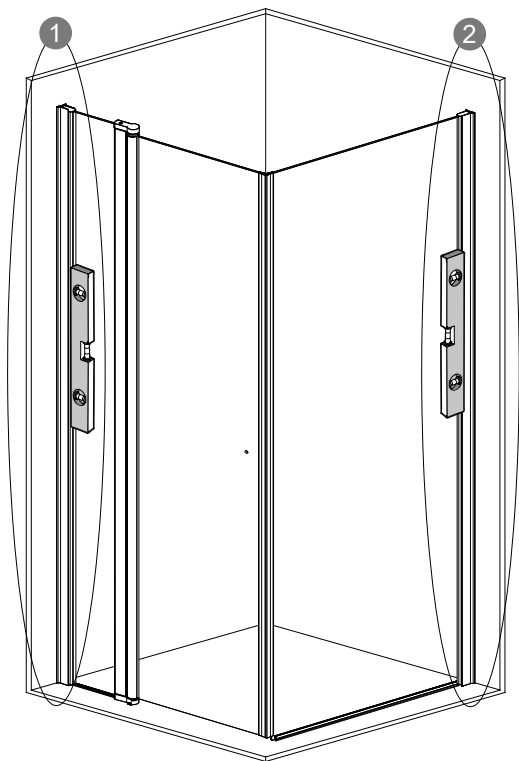



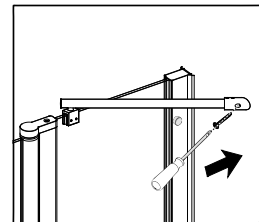
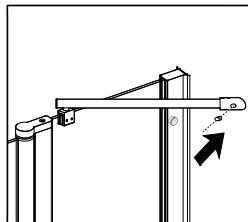
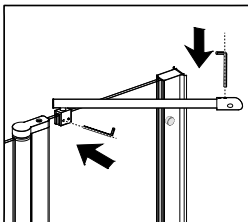
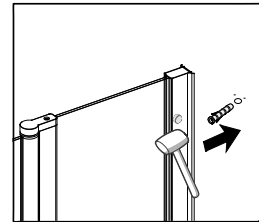

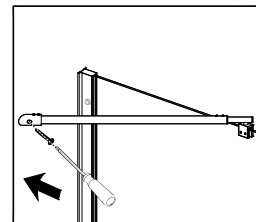
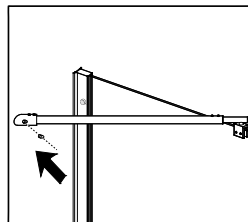
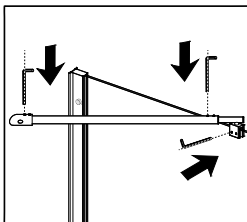
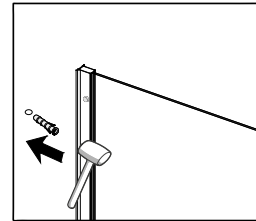
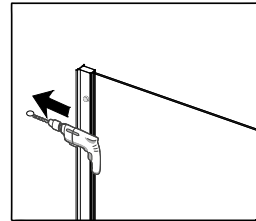
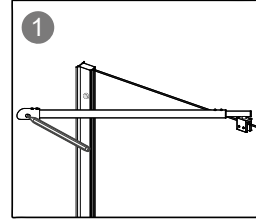
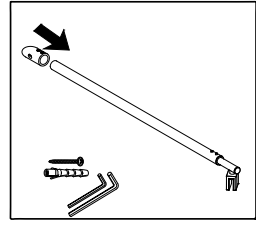
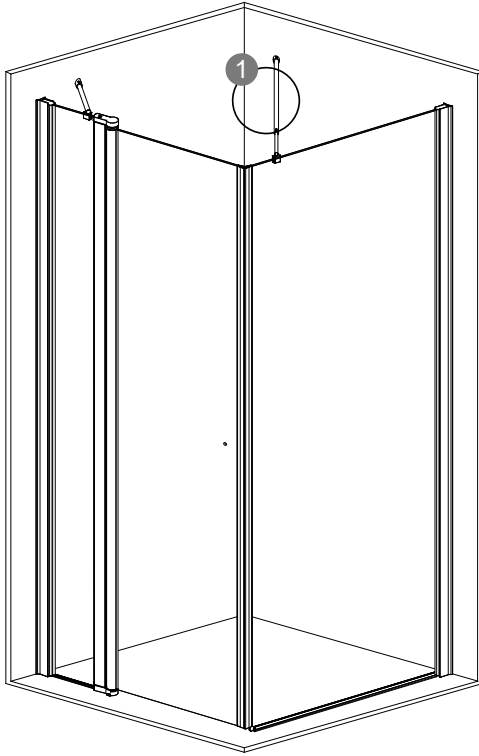

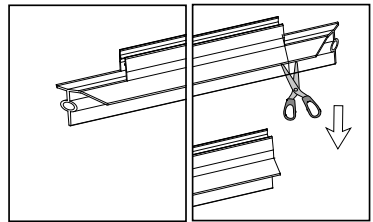
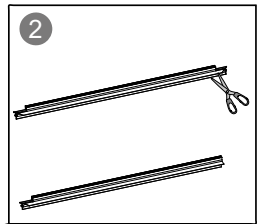
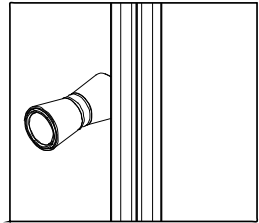
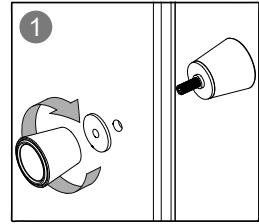
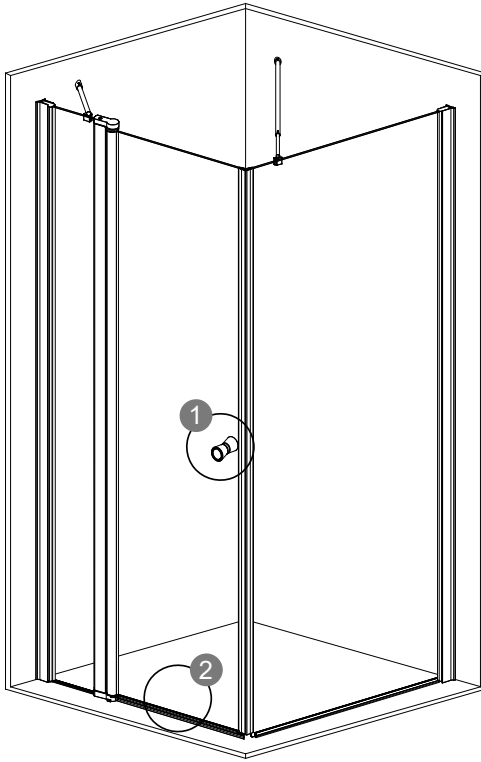

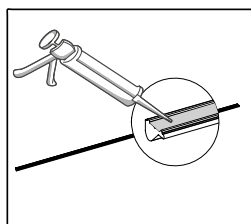
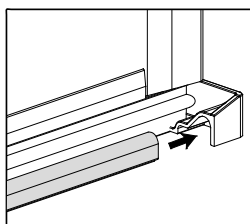
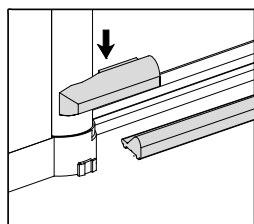
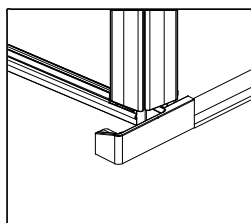
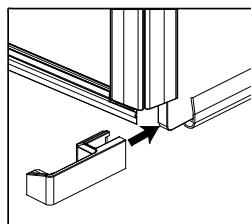
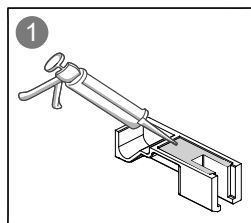
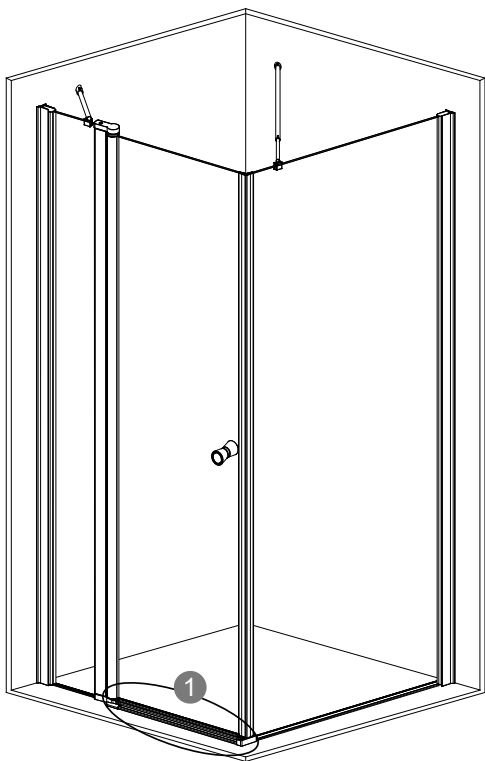

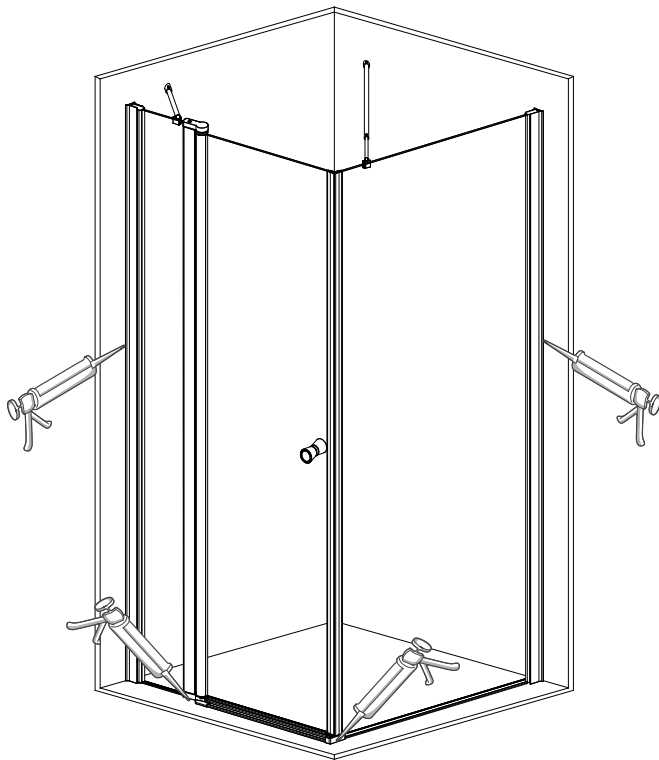



W3 \ W2		W1	800 765-785mm	900 865-885mm	1000 965-985mm
300	265-285mm		1030-1070mm	1130-1170mm	1230-1270mm
400	365-385mm		1130-1170mm	1230-1270mm	1330-1370mm
700	665-685mm		1430-1470mm	1530-1570mm	1630-1670mm
800	765-785mm		1530-1570mm	1630-1670mm	1730-1770mm
900	865-885mm		1630-1670mm	1730-1770mm	1830-1870mm
1000	965-985mm		1730-1770mm	1830-1870mm	1930-1970mm
1100	1065-1085mm		1830-1870mm	1930-1970mm	2030-2070mm
1200	1165-1185mm		1930-1970mm	2030-2070mm	2130-2170mm
1400	1365-1385mm		2130-2170mm	2230-2270mm	2330-2370mm

