



Roca

ROCA BOX UNIVERSAL SINGLE LEVER MIXER

L-90



A5A2B01



A5A0B01

THESIS



A5A2B50



A5A0B50

ESMAI



A5A2B31



A5A0B31

ATLAS



A5A2B90



A5A0B90

INSIGNIA



A5A2B3A



A5A0B3A

LANTA



A5A2B11



A5A0B11

M2



A5A2B68



A5A0B68

NAIA



A5A2B96



A5A0B96

LOGICA



A5A2B27



A5A0B27

L90

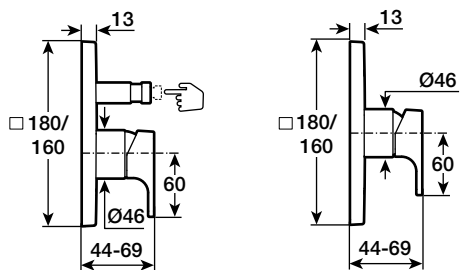

THESIS

[mm]

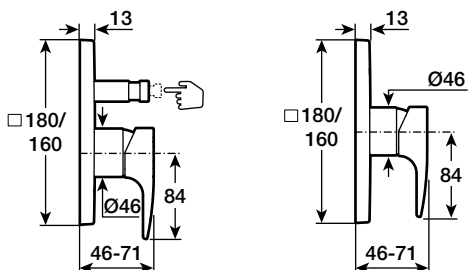

ESMAI

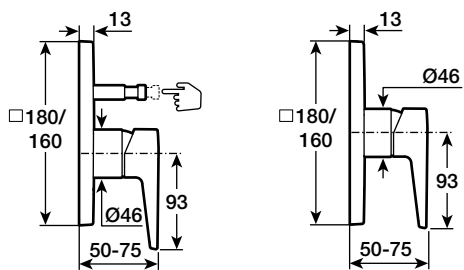

ATLAS

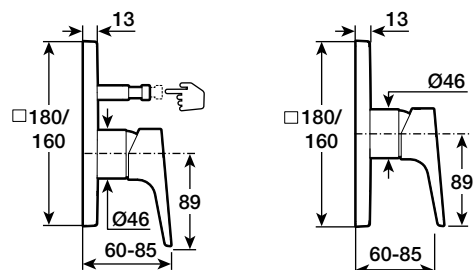

INSIGNIA

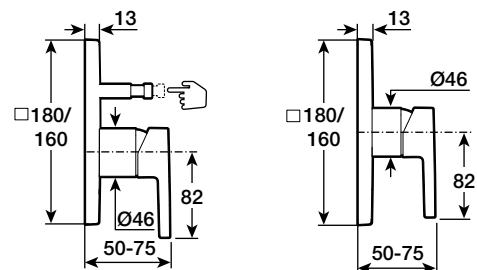

LANTA

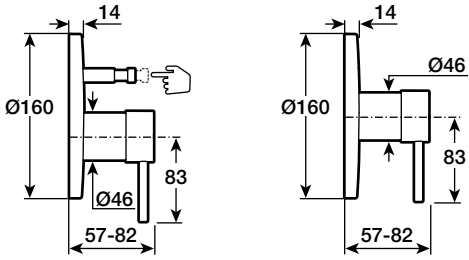

M2

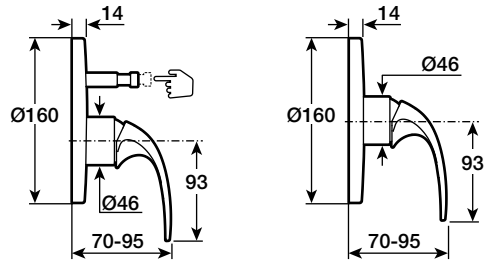

NAIA

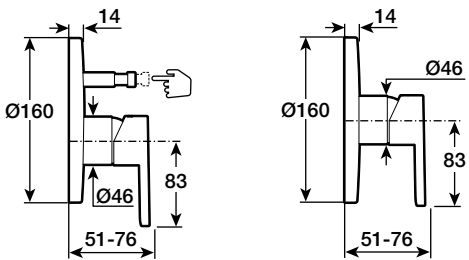

LOGICA

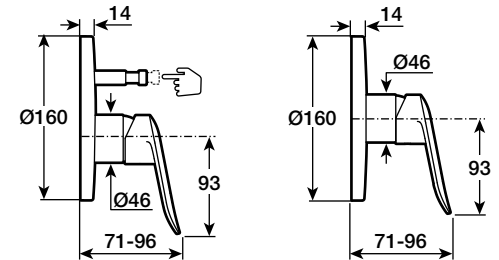



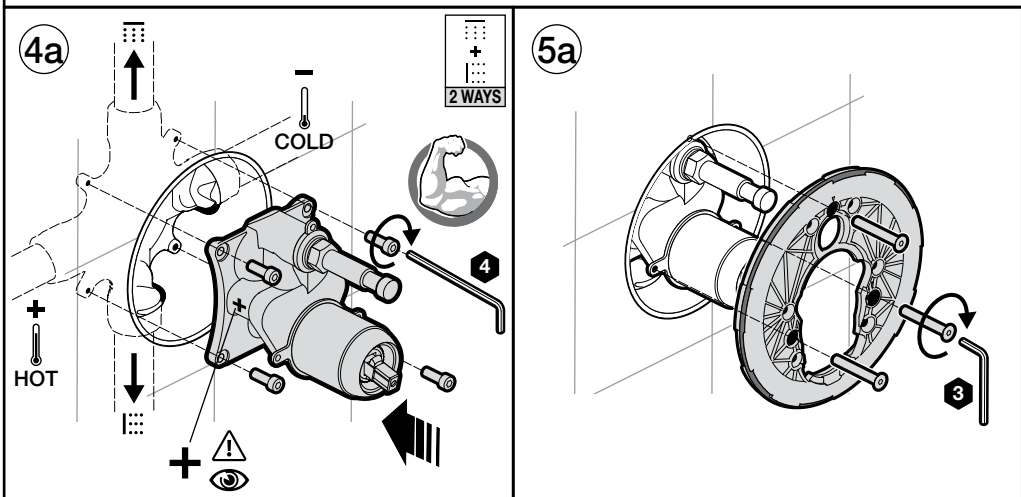
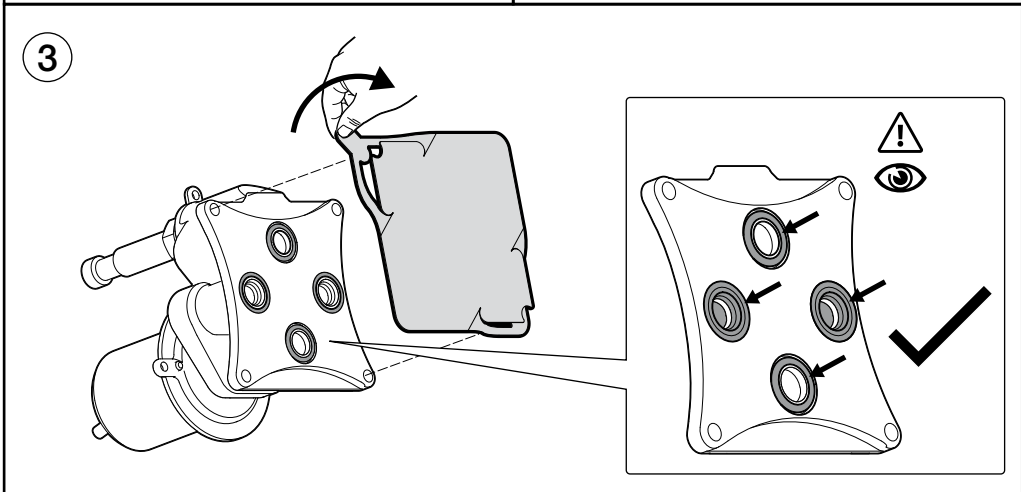
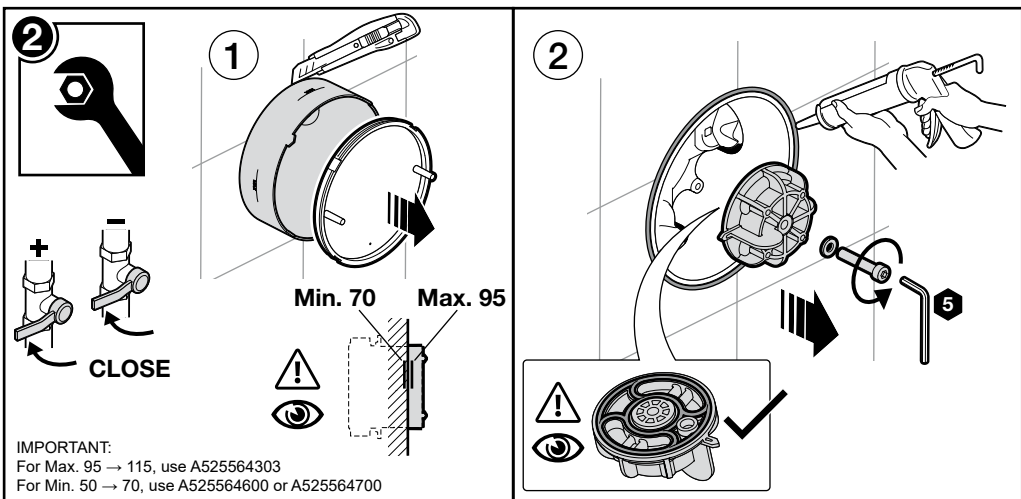

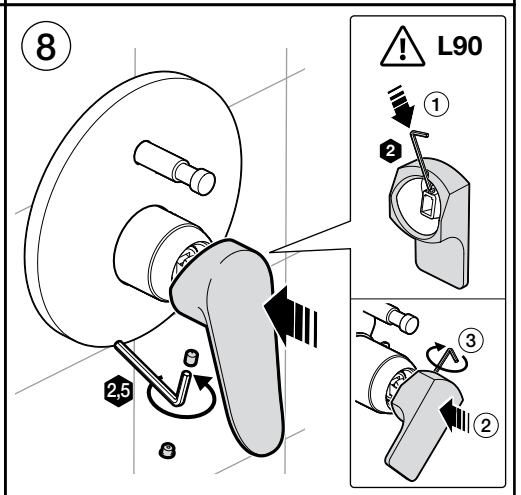
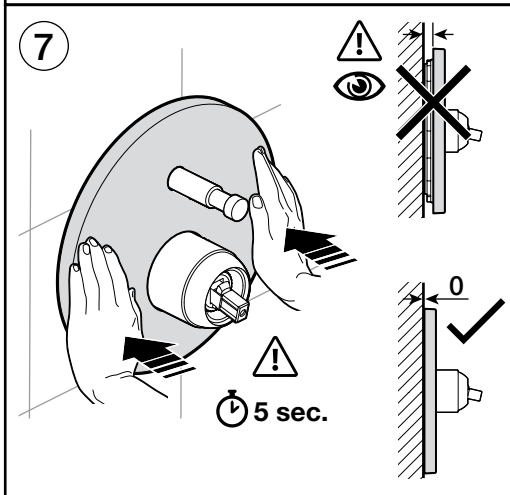
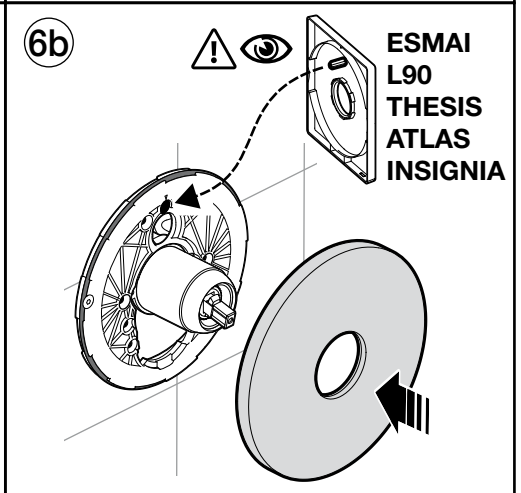
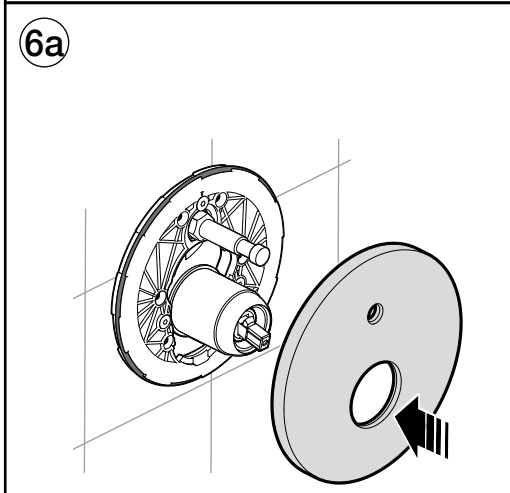
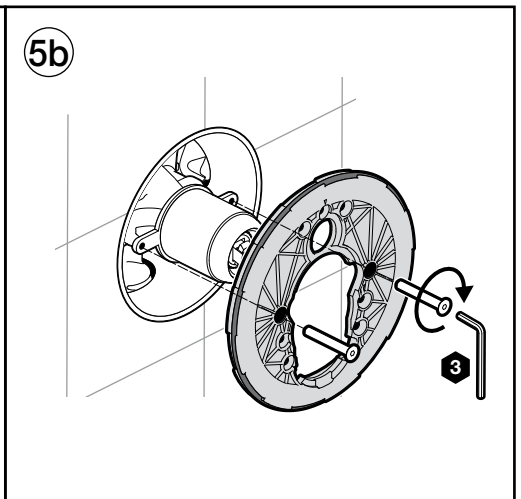
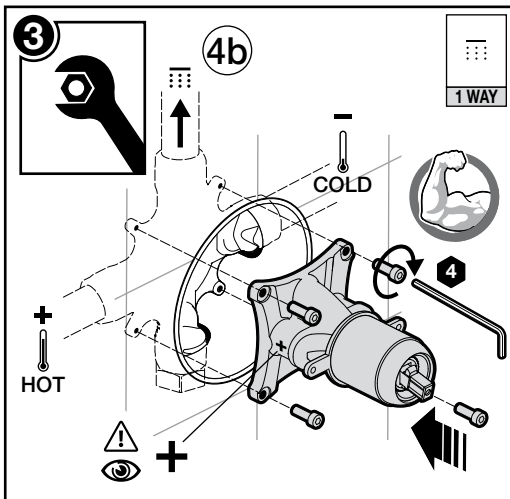

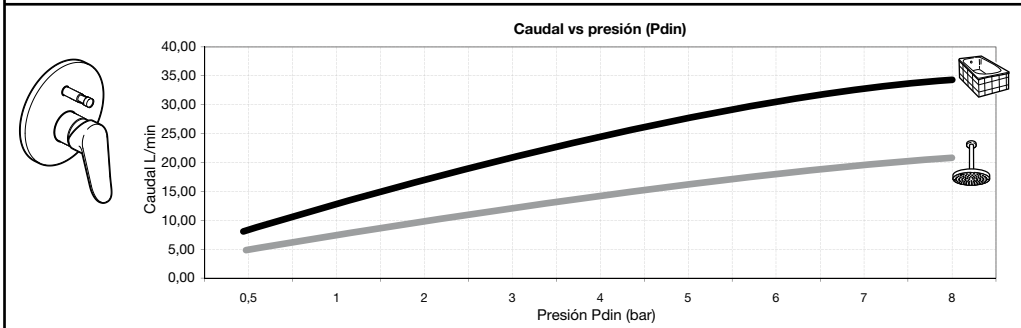
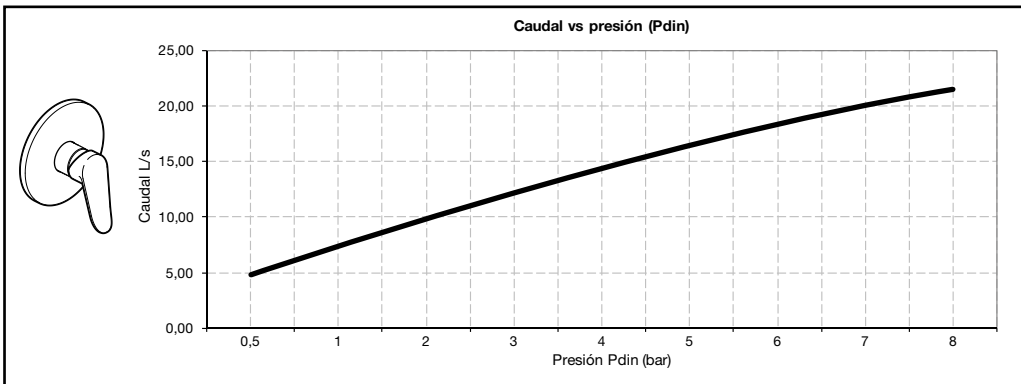
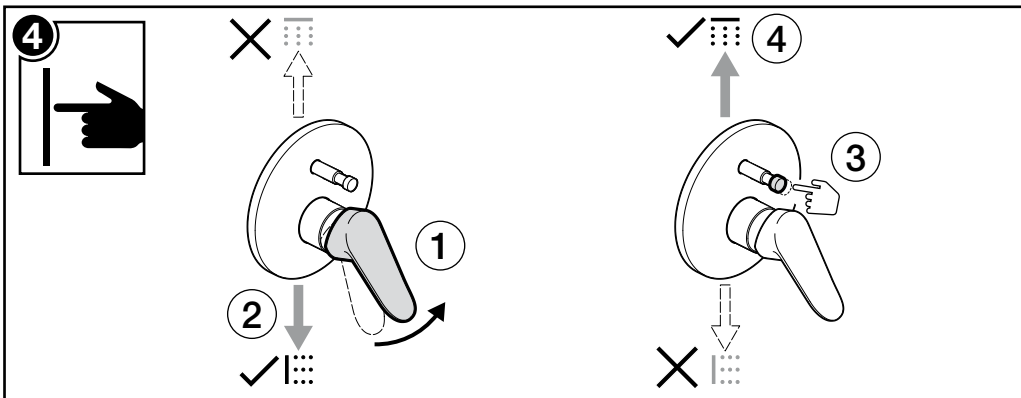





a				
 x1	 x1	 x3		
b				
 x1	 x1	 x2		
 x1	 x1	 x1	 x1	







 P 	P bar	 MAX 10	
 P 	P bar	MIN 1  5 MAX	 3 2 
  T	°C	 80 MAX.	 -65 -50 



A5A0B01	L90
A5A0B50	THESIS
A5A0B31	ESMAI
A5A0B11	LANTA
A5A0B68	M2
A5A0B27	LOGICA
A5A0B90	ATLAS
A5A0B96	NAIA
A5A0B3A	INSIGNIA

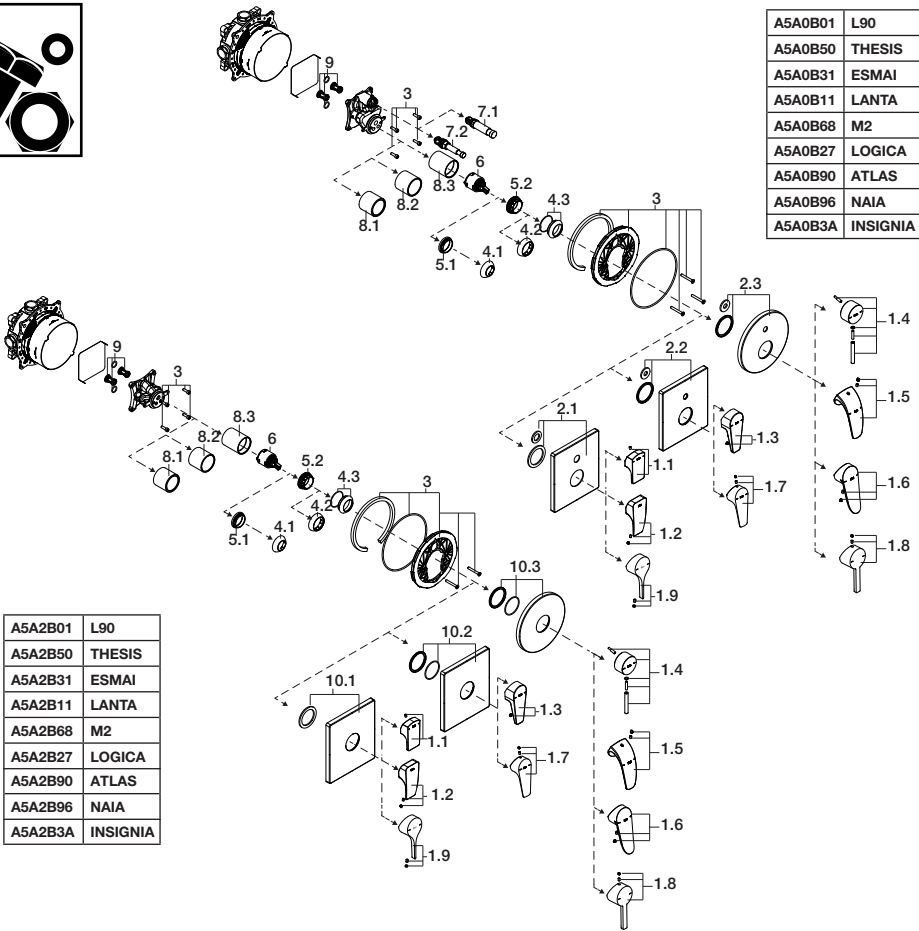

A5A2B01	L90
A5A2B50	THESIS
A5A2B31	ESMAI
A5A2B11	LANTA
A5A2B68	M2
A5A2B27	LOGICA
A5A2B90	ATLAS
A5A2B96	NAIA
A5A2B3A	INSIGNIA

1.1 - AG0041800R	L90
1.2 - A525022600	THESIS
1.3 - A525029600	ESMAI
1.4 - AG0121400R	LANTA
1.5 - AG0036900R	M2
1.6 - AG0018100R	LOGICA
1.7 - AG0116300R	ATLAS
1.8 - AG01370..R	NAIA
1.9 - AG01542..R	INSIGNIA
2.1 - AG0121900R	L90 THESIS INSIGNIA
2.2 - AG0121100R	ESMAI ATLAS LANTA
2.3 - AG01213..R	M2 LOGICA NAIA
3 - AG0120900R	
4.1 - AG0032100R	L90 M2 THESIS ESMAI LOGICA ATLAS NAIA INSIGNIA
4.2 - AG00853..R	NAIA INSIGNIA
4.3 - AG0121500R	LANTA

5.1 - A525027803	L90 M2 THESIS ESMAI LANTA
5.2 - A525023507	LOGICA ATLAS NAIA INSIGNIA
6 - AG0110607R	
7.1 - A525022800 AG02188CNR	L90 THESIS INSIGNIA
7.2 - A525006500 AG02186CNR	ESMAI LANTA M2 LOGICA ATLAS NAIA
8.1 - AG0121600R	L90 M2 THESIS ESMAI LOGICA ATLAS NAIA INSIGNIA
8.2 - A525006800 AG02189CNR	ESMAI LOGICA ATLAS NAIA INSIGNIA
8.3 - AG0121700R	LANTA
9 - AG0121000R	

10.1 - AG01271..R	L90 THESIS INSIGNIA
10.2 - AG0127000R	ESMAI ATLAS LANTA
10.3 - AG01212..R	M2 LOGICA NAIA

CÓDIGO / CODE

0000000 0

ACABADO / FINISH



www.roca.net

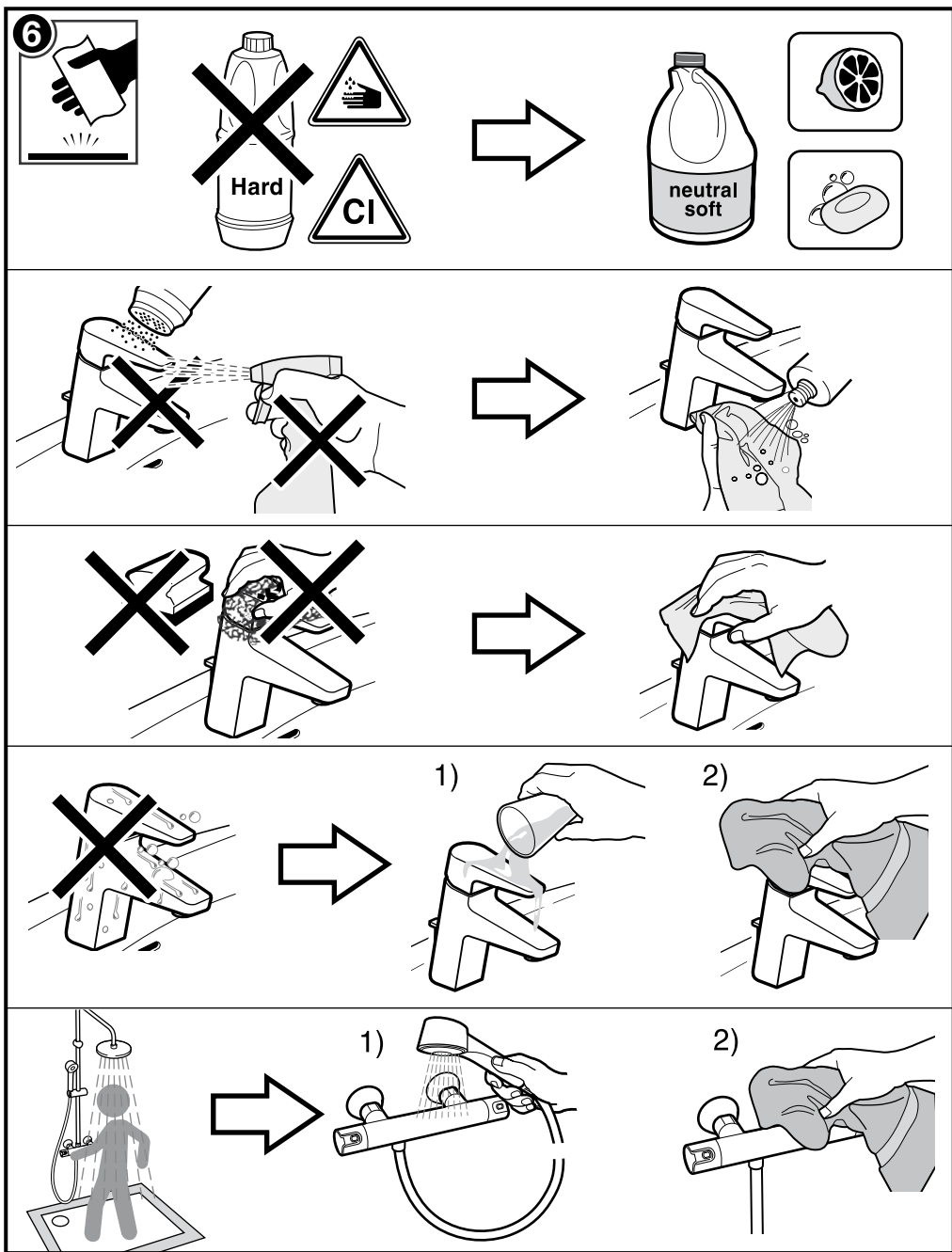

AS23094707P



Roca Sanitario, S.A.
 Avda. Diagonal, 513
 08029 Barcelona
 SPAIN
 www.roca.com

933 LÍNEA DE ATENCIÓN
661 AL CONSUMIDOR
266 ESPAÑA
 SERVICIO TÉCNICO
 ESPAÑA



productsupport.rs@roca.net
 soporteproducto.rs@roca.net